



### **ABRIR 3.- ELABORACIÓN Y DISCUSIÓN DE...**

## 4. - CONCLUSIONES

---

## 4. - Conclusiones

Las conclusiones más significativas del presente estudio experimental sobre transferencia de calor se muestran a continuación:

1. En todas las barras del sistema la temperatura aumenta a lo largo de su longitud. Esto indica que uno de los mecanismos involucrados en la transferencia de calor es la convección.
2. La presencia de rejilla espaciadora corta las líneas de flujo del fluido y modifica los perfiles longitudinales de temperatura de las barras, pudiéndose considerar que las barras quedan divididas en dos zonas que deben ser tratadas de forma independiente.
3. En el intervalo de condiciones de operación estudiado, la transferencia de calor por radiación coexiste junto a la transferencia de calor por convección, aunque los valores de temperaturas alcanzados sean bajos. La contribución a la transferencia de calor de la convección y radiación depende de varios factores como la presencia de rejillas espaciadoras, la geometría y dimensiones del sistema y la generación de calor en su interior.
4. El aumento del diámetro de carcasa (elemento equivalente a la pared del contenedor) mejora la transferencia de calor convectiva, ya que existe un mayor espacio anular entre haz y carcasa. Para una carcasa de tamaño fijo, un incremento del espaciado entre barras y de la multiplicidad del haz aumenta considerablemente la transferencia de calor convectiva desde el haz de barras hacia la carcasa exterior.
5. Se han deducido correlaciones individuales para cada barra y globales del haz completo que permiten calcular el número adimensional de Nusselt frente al Rayleigh. Las correlaciones son ecuaciones de tipo exponencial donde intervienen, además del número de Rayleigh, parámetros geométricos del sistema.
6. Los errores medios obtenidos al aplicar las correlaciones individuales del Nusselt son del orden del 4.4%, mientras que para las correlaciones globales son del 3.8 %. Dadas las incertidumbres en las medidas de temperaturas, donde la precisión considerada es de 1 °C, y dada la complejidad de los sistemas experimentales utilizados, se puede concluir que los valores del Nusselt teóricos

predichos tienen una proximidad satisfactoria con los valores obtenidos experimentalmente. Las correlaciones globales han sido verificadas con datos experimentales existentes en la bibliografía y se ha encontrado una buena concordancia.

7. La geometría de la carcasa influye en la transferencia de calor por convección. Las diferencias en las condiciones de contorno del sistema aparecen reflejadas en el valor del exponente del número de Rayleigh. Según el modelo de anillo equivalente, los sistemas de cilindros concéntricos (haz de barras y carcasa cilíndrica) presentan un régimen de flujo laminar, dado que el valor del exponente es próximo a 0.25. Sin embargo en los sistemas de cuadrados concéntricos (haz de barras y carcasa cuadrada) el régimen de flujo tiende a ser turbulento y el valor del exponente del número de Rayleigh está más próximo a 0.33. Así, desde el punto de vista de la modelización de la transferencia de calor en el interior de los contenedores, cestas de geometría cilíndrica aseguran un predecible flujo laminar, incluso para números de Rayleigh superiores a los recogidos en la bibliografía para cambio de régimen de flujo, mientras que cestas cuadradas conducen a un régimen próximo al de transición entre el laminar y el turbulento, situación más difícil de reproducir y modelizar.
8. En los sistemas provistos de rejilla central espaciadora han sido obtenidas dos correlaciones del número de Nusselt global, una para la zona inferior de la rejilla y otra para la zona superior, que difieren únicamente en el valor de la constante. Se observa una similitud de los Nusselt globales de la zona inferior con haces de barras sin rejilla central. Sin embargo la zona superior de haces con rejilla central tiene números de Nusselt globales inferiores en un 50%. Esto demuestra la poca influencia que tiene la longitud de las barras y la importancia que tiene la presencia y geometría de la rejilla desde donde se inicia el flujo convectivo. Por esta razón, en los modelos térmicos de contenedores de almacenamiento deben introducirse correlaciones que consideren la presencia de rejillas espaciadoras.
9. La temperatura máxima alcanzada en el interior del haz de barras puede ser obtenida a partir del número de Rayleigh global modificado, calor neto total transferido por convección, parámetros geométricos del haz y valores de las propiedades termofísicas del aire a la temperatura media entre carcasa y barra central. Una comparación de los resultados experimentales de temperatura máxima con los valores obtenidos mediante predicciones, indica que los errores medios cometidos son inferiores al 5 %.

## 5. - NOMENCLATURA

---

## 5. – Nomenclatura

$a$	Espacio anular entre haz y carcasa ( $D_C - D_{haz}$ ), m
$A$	Superficie de transferencia de calor, $m^2$
$d$	Diámetro de barra, cm
$D_C$	Diámetro de carcasa, cm
$D_{haz}$	Diámetro equivalente del haz, cm
$F_{ij}$	Factor de visión de la superficie "i" con respecto a la "j"
$g$	Aceleración de la gravedad, $m/s^2$
$Gr_x$	Número adimensional de Grashof ( $g\beta x^3 \Delta T / \nu_f^2$ )
$h_c$	Coefficiente de transferencia de calor por convección, $W/(m^2 \text{ } ^\circ C)$
$K$	Relación anular entre diámetros de carcasa y haz ( $D_C / D_{haz}$ )
$k$	Conductividad térmica, $W/(m \text{ } ^\circ C)$
$L$	Longitud o altura del haz de barras, m
$l$	Longitud de lámina de rejilla, cm
$L_C$	Lado de carcasa cuadrada, cm
$M$	Multiplicidad del haz o número de barras en la diagonal
$Nu_a$	Nusselt global tipo <i>annulus</i> ( $(h_c)_G a / k_f$ )
$Nu_d$	Nusselt individual de barra ( $h_c d / k_f$ )
$Pr$	Número adimensional de Prandtl ( $\nu_f / \alpha_f$ )
$q$	Flujo de calor, $W/m^2$
$Q$	Caudal de calor, W
$R$	Radiosidad en la superficie de barra, $W/m^2$
$r$	Reflectancia de superficie
$Ra_x$	Número adimensional de Rayleigh ( $Gr_x Pr$ )
$Ra_d$	Rayleigh individual de barra ( $g\beta d^3 \Delta T / (\alpha_f \nu_f)$ )
$Ra_a$	Rayleigh global tipo <i>annulus</i> ( $g\beta a^3 \Delta T / (\alpha_f \nu_f)$ )
$Ra_a^*$	Rayleigh global <i>annulus</i> modificado ( $Ra_a Nu_a$ )
$R_t$	Resistencia térmica de rejilla, $^\circ C/W$
$S$	Relación de espaciado y diámetro de barra ( $SP/d$ )
$SP$	Espaciado entre barras anexas, cm

$T$	Temperatura local, °C
$\Delta T$	Incremento de temperaturas, °C
$t$	Tiempo transcurrido, s
$Y$	Distancia desde el centro del haz, cm
$Z$	Distancia desde la base del haz, cm

Símbolos griegos

$\alpha$	Difusividad térmica, m <sup>2</sup> /s
$\beta$	Coefficiente isobárico de expansión térmica, 1/K
$\nu$	Viscosidad cinemática, m <sup>2</sup> /s
$\eta$	Contribución a la transferencia de calor
$\rho$	Densidad, Kg/m <sup>3</sup>
$\varepsilon$	Emisividad de superficie
$\xi$	Error medio de correlaciones
$\sigma$	Constante de Stefan-Boltzmann, W/(m <sup>2</sup> K <sup>4</sup> )

Subíndices

$B$	Base del sistema
$C$	Carcasa del sistema
$f$	Película de aire en la capa límite
$G$	Global

## 6. - REFERENCIAS BIBLIOGRÁFICAS

---



## 6. - Referencias bibliográficas

- AEN/OCDE, 1989. “Gestión de Combustible Nuclear Irradiado. Experiencia y Opciones”. Ed. Consejo de Seguridad Nuclear. Madrid.
- ALONSO PACHECO, J.M., 1997. “Tecnología de diseño mecánico del combustible”. El Ciclo de Combustible Nuclear. Sociedad Nuclear Española. Ed. Senda. Madrid.
- ALVAREZ MIR, F., 1998. “Opciones internacionales de almacenamiento temporal de combustible gastado”. Seminario de Residuos Radiactivos. Foro Nuclear. Madrid.
- ARIMILLI, R.V., PARANG, M. y SURAPANEMI, P.R., 1986. “Heat transfer from circular tubes in a semi-infinite medium”. Journal of Heat Transfer **108**. 703-705.
- BEJAN, A., 1984. “Convection Heat Transfer”. John Wiley & Sons. New York.
- BELL, M.J., 1973. “ORIGEN - The ORNL Isotope Generation and Depletion Code”. ORNL-4628. U.S. Atomic Energy Commission. Washington.
- BRYAN, C.B. y CHILDS, K.W., 1985 “Thermal Codes Benchmarking Heating 6 results”. K CSD TM 57. Oak Ridge National Laboratorie (Gaseous Diffusion Plant). Tennessee.
- COLEGIO OFICIAL DE FISICOS, 1997. “Tratamiento y Gestión de Residuos Radiactivos”. Madrid.
- COSTA, E., CALLEJA, G., OVEJERO, G., LUCAS, A., AGUADO, J. y UGUINA, M.A., 1986. “Ingeniería Química 4. Transmisión de Calor”. Ed. Alhambra Universidad. Madrid.
- CREER, J.M., 1984. “Decay heat and heat transfer. Predictions for spent fuel storage systems”. PNL-SA-12658. Pacific Northwest Laboratories. Richland (Washington).
- ENERGÍA, 1999. Foro de la Industria Nuclear Española. Madrid.

- ENRESA, 1994. “Cuarto Plan General de Residuos Radiactivos”. Ministerio de Industria y Energía. Madrid.
- ESTRATOS, 1996. “El contenedor ENSA-DPT”. 36. ENRESA. Madrid.
- FLASH NUCLEAR, 1998. 375. Foro de la Industria Nuclear Española. Madrid.
- GAJO, J.A., 1993. “Contenedores para combustible gastado”. Sociedad Nuclear Española. Ed. Senda.
- GLASSTONE, S. y SESONSKE, A., 1982. “Ingeniería de Reactores Nucleares”. Ed. Reverté. Barcelona.
- GRAVALOS, J.M. y GAJO, J.A., 1995. “Development of dual purpose (storage and transport) metal cask in Spain”. Proceeding of an International Symposium on Safety and Engineering Aspect of Spent Fuel Storage”. IAEA. Vienna.
- HECKEL, J.J., CHEN, T.S. y ARMALY, B.F., 1989. “Mixed convection along slender vertical cylinders with variable surface temperature”. Int. J. Heat Mass Transfer 32. 1431-1442.
- HSIEH S.S. y WANG C.Y., 1994. “Experimental study of three-dimensional natural convection in enclosures with different working fluids”. Int. J. Heat Mass Transfer 37. 2687-2698.
- IAEA, 1983. “Handling and Storage of Conditioned High-Level Wastes”. Technical Reports Series N° 229. Vienna.
- JUUL, N.H., 1982. “View factors in radiation between two parallel oriented cylinders of finite lengths”. Journal of Heat Transfer 104. 384-389.
- KEYHANI, M., KULACHI, F.A. y CHRISTENSEN, R.N., 1983. “Free convection in a vertical annulus with constant heat flux on the inner wall”. Journal of Heat Transfer 105. 454-458.

- KEYHANI, M., KULACHI, F.A. y CHRISTENSEN, R.N., 1985. "Experimental Investigation of free convection in a vertical rod bundle. A general correlation for Nusselt numbers". *Journal of Heat Transfer* **107**. 611-623.
- KREITH, F. y BLACK, W.Z., 1983. "La Transmisión de Calor. Principios fundamentales". Ed. Alhambra Universidad. Madrid.
- KUMAR, R. y KALAM, M.A., 1991. "Laminar thermal convection between vertical coaxial isothermal cylinders". *Int. J. Heat Mass Transfer* **34**. 513-524.
- LA PICA, A., RODONÒ, G. y VOLPES, R., 1993. "An experimental investigation on natural convection of air in a vertical channel". *Int. J. Heat Mass. Transfer* **36**. 611-616.
- LEMEMBRE, A. y PETIT, J.P., 1998. "Laminar natural convection in a laterally heated and upper cooled vertical cylindrical enclosure". *Int. J. Heat Transfer* **41**. 2437-2454.
- LOMBARDO, N.J., CUTA, J.M., MITCHENER, T.E. y WHEELER, C., 1986. "COBRASFS: A Thermal-Hydraulic Analysis Computer Code. Vol. III - Validations Assessments". PNL-6049. Pacific Northwest Laboratories. Richland (Washington).
- McADAMS, W.H., 1978. "Transmisión de Calor". McGraw-Hill. Méjico.
- McCANN, R.A., 1980. "HYDRA-I: A three dimensional finite difference code for calculation the thermo-hydraulic performance of a fuel assembly contained within a canister". PNL-3367. Pacific Northwest Laboratories. Richland (Washington).
- NECATI, M., 1979. "Transferencia de Calor". Ed. McGraw-Hill Latinoamericana S.A. Bogotá.
- NITSCHKE, F. y RUDOLF C.H., 1986. "Heat transfer investigations for spent assemblies in a dry cask". *Packaging and Transportation of Radioactive Materials* **1**. IAEA. Vienna.
- PAJARES, V., 1986. "Estudio térmico de tubos verticales con generación de calor". Universidad Complutense. Madrid.

- RAMIREZ ONTALBA, E., 1997. "Tratamiento de combustible irradiado". El Ciclo de Combustible Nuclear. Sociedad Nuclear Española. Ed. Senda. Madrid.
- RAO, Y.F. y CLAKPE, E.K., 1993. "Three - dimensional natural convection in an enclosed vertical rod bundle with mixed boundary conditions". *Int. J. Heat Mass Transfer* **36**. 1517-1528.
- RECTOR, D.R., WEELER, C.L. y LOMBARDO, H.J., 1986a. "COBRA-SFS: A Thermal Hydraulic Analysis Computer Code". **1**. PNL-6049. Pacific Northwest Laboratories. Richland (Washington).
- RECTOR, D.R., WEELER, C.L. y MICHENER, T., 1986b. "COBRA-SFS: Modifications and Cask Model Optimization". PNL-6706. Pacific Northwest Laboratories. Richland (Washington).
- ROSHENOW, W.M. y HARNETT, J.P., 1973. "Handbook of Heat Transfer". Ed. MacGraw-Hill. New York.
- RUIZ, C., 1992. "Almacenamiento temporal del combustible irradiado. Soluciones técnicas y criterios de seguridad". *Gestión de Residuos Radiactivos* **2**. Ed. CIEMAT. Madrid.
- SCMITTEN, P.E. y WRIGHT, J.B., 1980. "Thermal Evaluation of Sealed Storage Cask Containing Spent Fuel". DOE/NV/00597-3. Pittsburg (Pennsylvania).
- SPILKER, H., 1989. "Natural convection cooling of heat producing radioactive waste in transport and storage casks". *Kerntechnik* **54** (4), 270.
- TAN, Z. y HOWELL, J.R., 1991. "Combined radiation and natural convection in a two dimensional participating square medium". *Int. J. Heat Mass Transfer* **34**. 785-793.
- THOMAS, R.W. y DE VAHL DAVIS, G., 1970. "Natural convection in annular and rectangular cavities. A numerical study". *Proceeding of Fourth Int. Heat Transfer Conference, Vol. 4. Paper NC 2.4*. Elsevier. Amsterdam.

- WATSON, S.J., 1983. "Heat transfer from spent reactor fuels during shipping. A proposed method for predicting temperature distribution in fuel bundles and comparison with experimental data". ORNL-3439. Oak Ridge National Lab. Tennessee.
- YANG, S.M., 1987. "General correlating equations for free convection heat transfer from a vertical cylinder". Heat Transfer Science and Technology. Hemisphere Publishing Corporation. Washington.
- YASUYUKI T., 1984. "Three dimensional natural convection in a inclined cylindrical annulus". *Int. J. Heat Mass Transfer* 27. 747-754.

## APÉNDICE A : DATOS EXPERIMENTALES

---

**A.1. - Configuración 1x1. Carcasa cilíndrica**

**A.1.1. - Configuración 1 X 1**  
 Carcasa cilíndrica (Dc = 3.5 cm)  
 Potencia= 2.7 W/barra. Tamb.= 17 °C

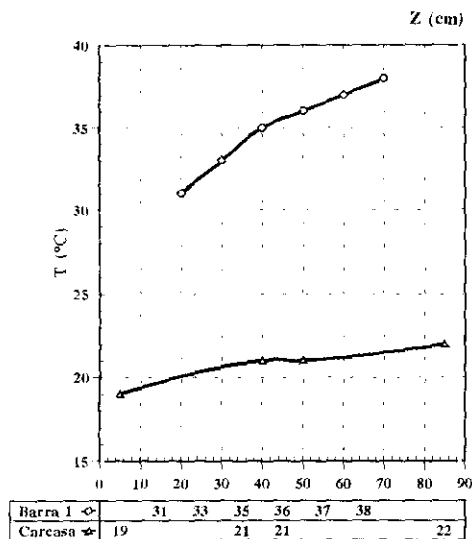

**A.1.2. - Configuración 1 X 1**  
 Carcasa cilíndrica (Dc = 3.5 cm)  
 Potencia= 8.6 W/barra. Tamb.= 18 °C

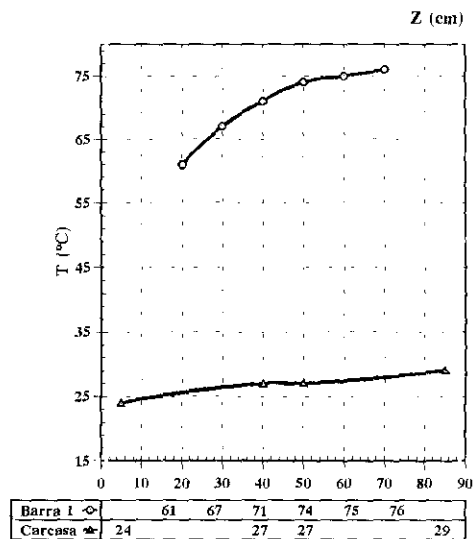

**A.1.3. - Configuración 1 X 1**  
 Carcasa cilíndrica (Dc = 3.5 cm)  
 Potencia= 18.0 W/barra. Tamb.= 18 °C

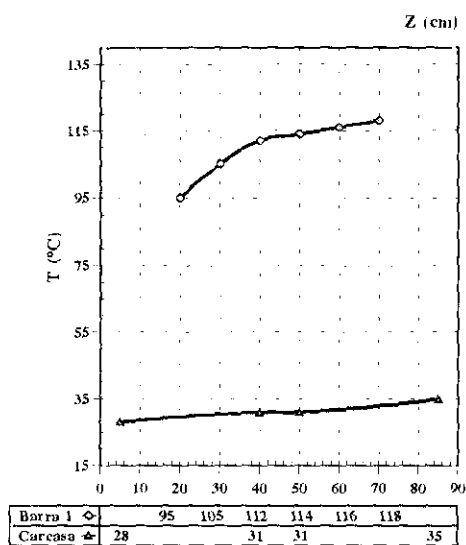

**A.1.4. - Configuración 1 X 1**  
 Carcasa cilíndrica (Dc = 3.5 cm)  
 Potencia= 32.7 W/barra. Tamb.= 18 °C

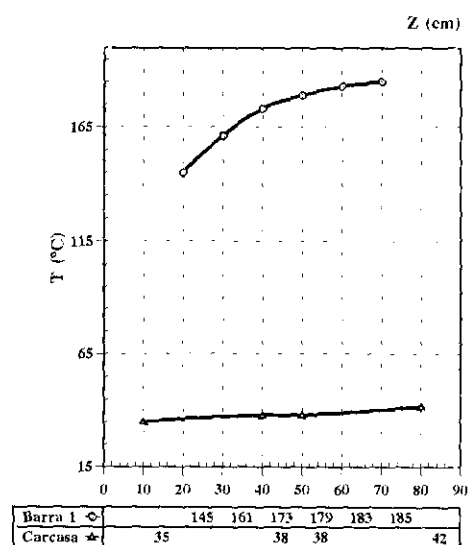

**A.1.5. - Configuración 1 X 1**  
**Carcasa Cilíndrica (Dc = 3.5 cm)**  
**Potencia= 45.0 W/barra. Tamb.= 19 °C**

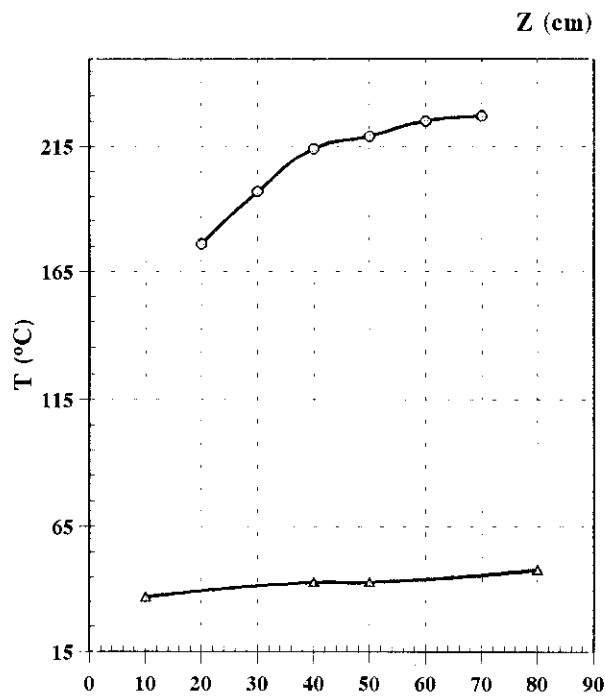

Barra 1 ◊	176	197	214	219	225	227
Carcasa ▲	37	43	43			48



**A.1.6. - Configuración 1 X 1**  
**Carcasa Cilíndrica (De = 6.0 cm)**  
**Potencia= 2.7 W/barra. Tamb.= 19 °C**

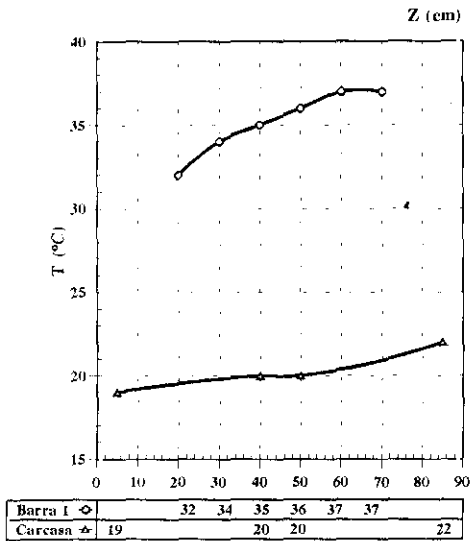

**A.1.7. - Configuración 1 X 1**  
**Carcasa Cilíndrica (De = 6.0 cm)**  
**Potencia= 8.6 W/barra. Tamb.= 19 °C**

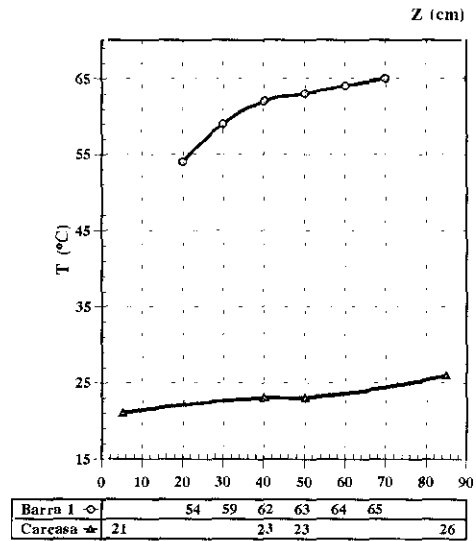

**A.1.8. - Configuración 1 X 1**  
**Carcasa Cilíndrica (De = 6.0 cm)**  
**Potencia= 18.0 W/barra. Tamb.= 21 °C**

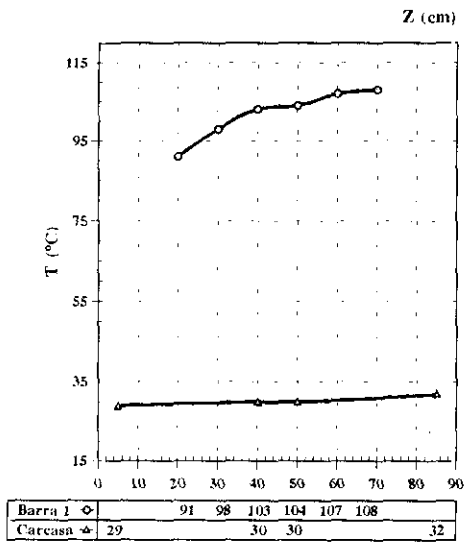

**A.1.9. - Configuración 1 X 1**  
**Carcasa cilíndrica (De = 6.0 cm)**  
**Potencia= 32.7 W/barra. Tamb.= 21 °C**

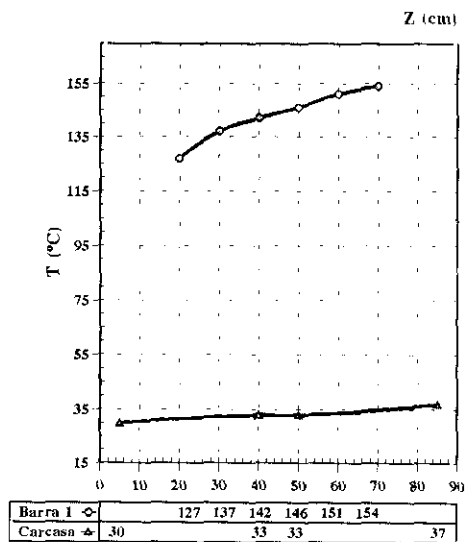

**A.1.10. - Configuración 1 X 1**  
**Carcasa Cilíndrica (Dc = 6.0 cm)**  
**Potencia= 45.0 W/barra. Tamb.= 21 °C**

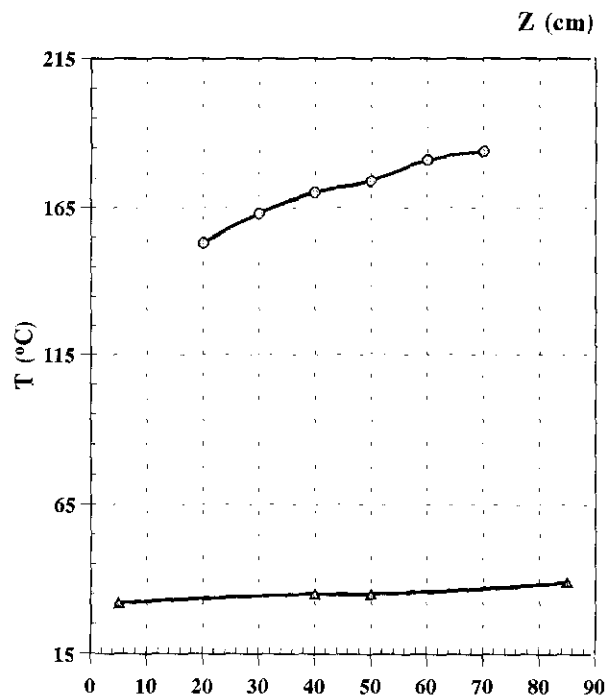

Barra 1 ◊	153	163	170	174	181	184
Carcasa ☆	32		35	35		39

**A.1.11. - Configuración 1 X 1**  
**Carcasa Cilíndrica (Dc = 10.4 cm)**  
**Potencia= 2.7 W/barra. Tamb.= 20 °C**

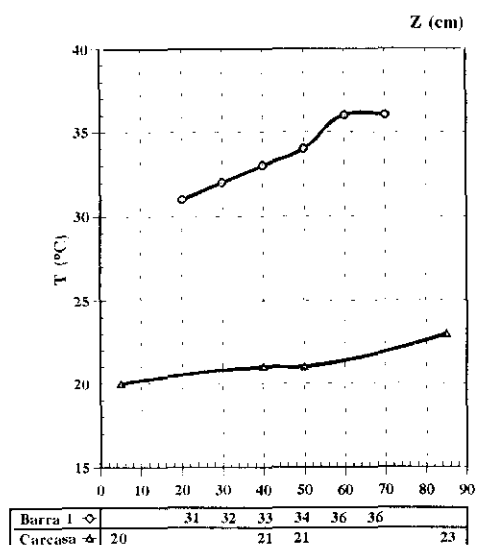

**A.1.12. - Configuración 1 X 1**  
**Carcasa cilíndrica (Dc = 10.4 cm)**  
**Potencia= 8.6 W/barra. Tamb.= 21 °C**

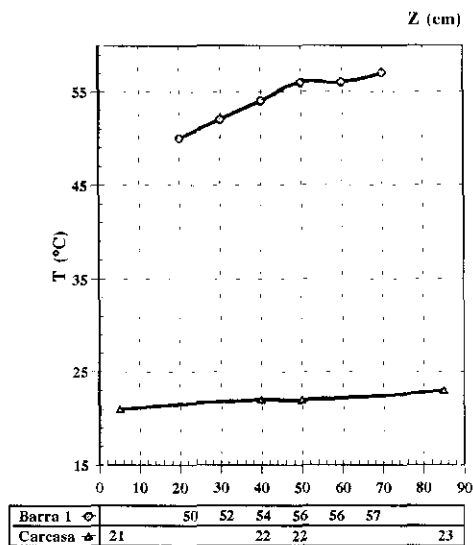

**A.1.13. - Configuración 1 X 1**  
**Carcasa cilíndrica (Dc = 10.4 cm)**  
**Potencia= 18.0 W/barra. Tamb.= 22 °C**

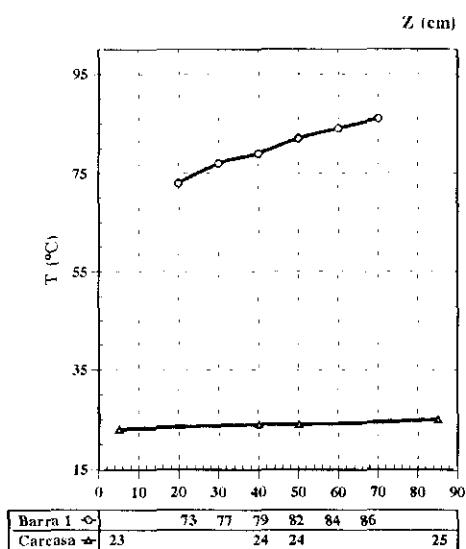

**A.1.14. - Configuración 1 X 1**  
**Carcasa cilíndrica (Dc = 10.4 cm)**  
**Potencia= 32.7 W/barra. Tamb.= 22 °C**

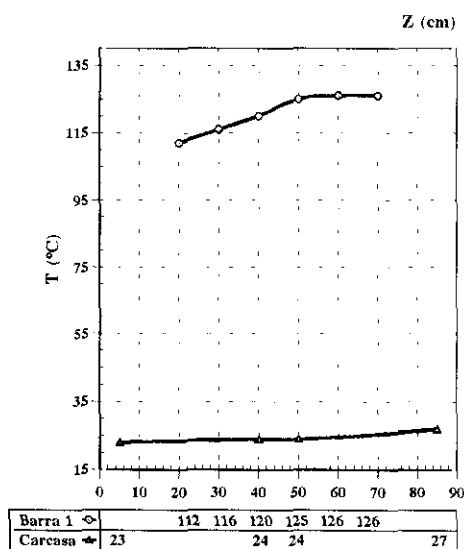

**A.1.15. - Configuración 1 X 1**  
**Carcasa cilíndrica (Dc = 10.4 cm)**  
**Potencia= 45.0 W/barra. Tamb.= 23 °C**

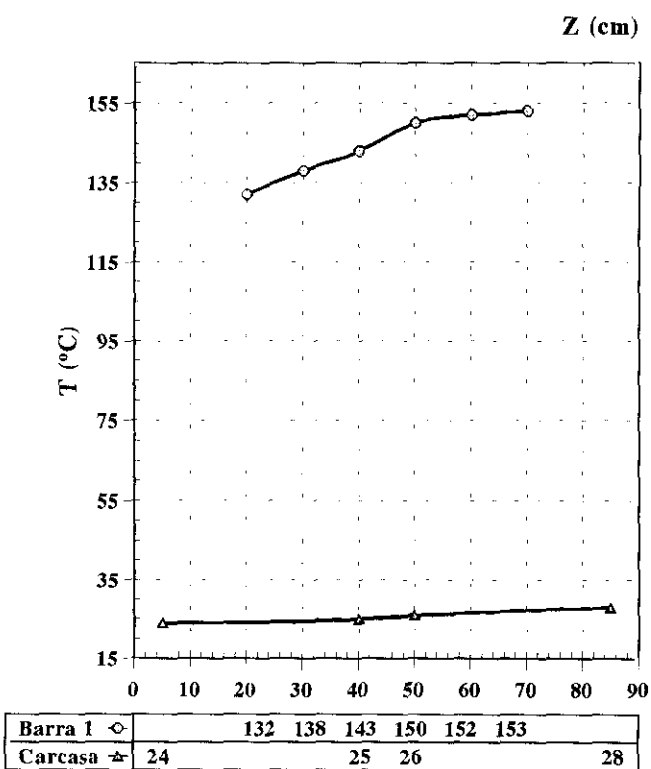

**A.2.- Carcasa cilíndrica. Espaciado de 2.6 cm**

**A.2.1. - Configuración 3 X 3. SP = 2.6 cm**  
 Carcasa cilíndrica (Dc = 10.4 cm)  
 Potencia = 2.7 W/barra. Tamb. = 22 °C

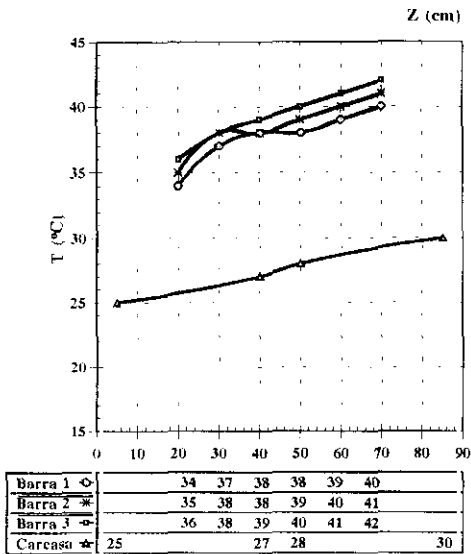

**A.2.2. - Configuración 3 X 3. SP = 2.6 cm**  
 Carcasa cilíndrica (Dc = 10.4 cm)  
 Potencia = 5.7 W/barra. Tamb. = 28 °C

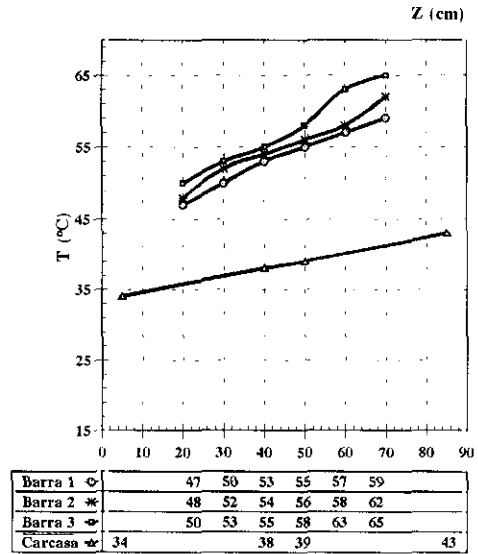

**A.2.3. - Configuración 3 X 3. SP = 2.6 cm**  
 Carcasa cilíndrica (Dc = 10.4 cm)  
 Potencia = 8.6 W/barra. Tamb. = 28 °C

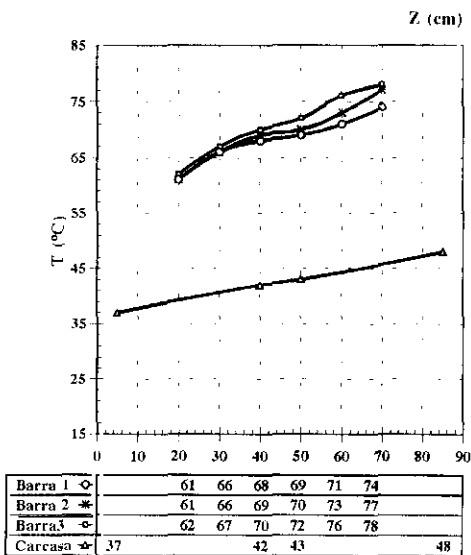

**A.2.4. - Configuración 3 X 3. SP = 2.6 cm**  
 Carcasa cilíndrica (Dc = 10.4 cm)  
 Potencia = 18.0 W/barra. Tamb. = 28 °C

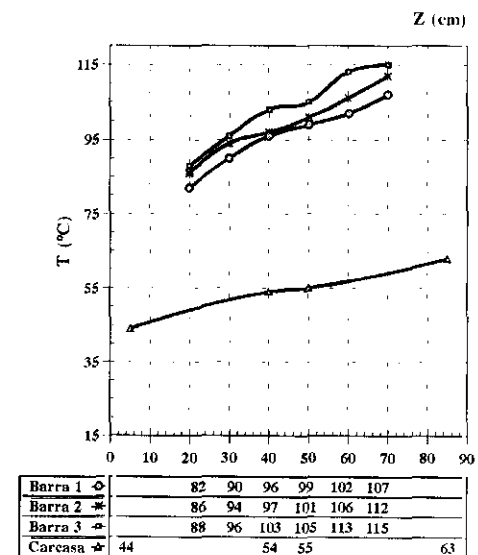

APÉNDICE A : DATOS EXPERIMENTALES

**A.2.5. - Configuración 3 X 3. SP = 2.6 cm**  
 Carcasa cilíndrica (Dc = 17.8 cm)  
 Potencia= 2.7 W/barra. Tamb.= 24 °C

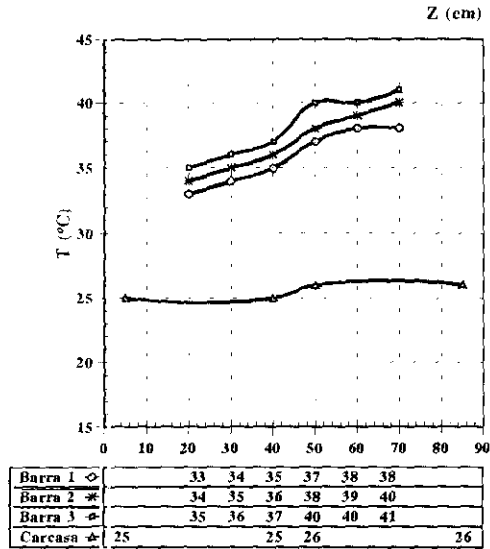

**A.2.6. - Configuración 3 X 3. SP = 2.6 cm**  
 Carcasa cilíndrica (Dc = 17.8 cm)  
 Potencia= 8.6 W/barra. Tamb.= 22 °C

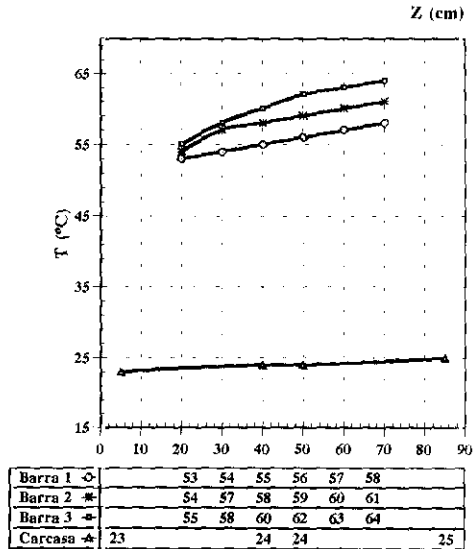

**A.2.7. - Configuración 3 X 3. SP = 2.6 cm**  
 Carcasa cilíndrica (Dc = 17.8 cm)  
 Potencia= 18.0 W/barra. Tamb.= 21 °C

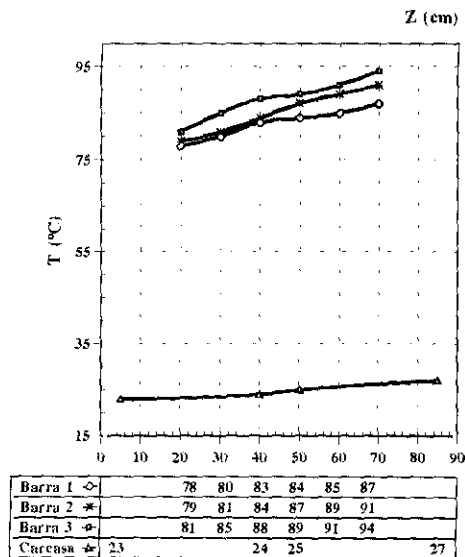

**A.2.8. - Configuración 3 X 3. SP = 2.6 cm**  
 Carcasa cilíndrica (Dc = 17.8 cm)  
 Potencia= 32.7 W/barra. Tamb.= 28 °C

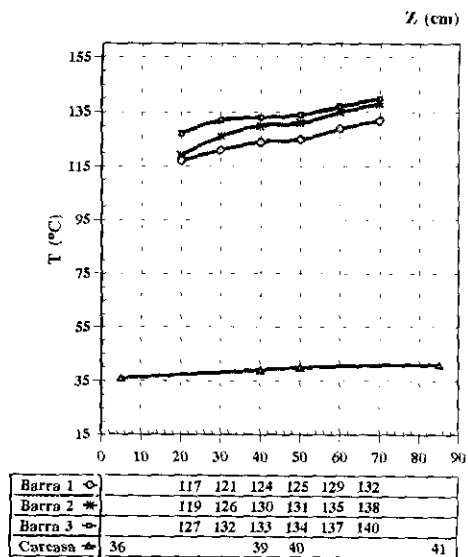

**A.2.9. - Configuración 3 X 3. SP = 2.6 cm**  
**Carcasa cilíndrica (Dc = 17.8 cm)**  
**Potencia= 53.7 W/barra. Tamb.= 28 °C**

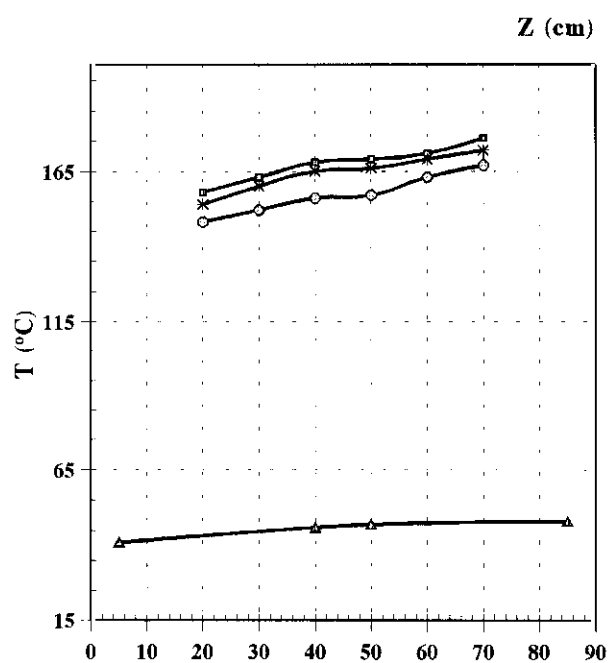

Barra 1 ◯	148	152	156	157	163	167
Barra 2 *	154	160	165	166	169	172
Barra 3 ◻	158	163	168	169	171	176
Carcasa △	41		46	47		48

APÉNDICE A : DATOS EXPERIMENTALES

A.2.10. - Configuración 3 X 3. SP = 2.6 cm  
Carcasa cilíndrica (Dc = 34.5 cm)  
Potencia= 2.7 W/barra. Tamb.= 27 °C

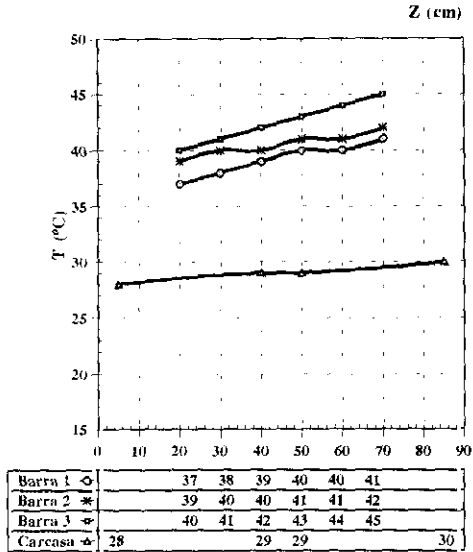

A.2.11. - Configuración 3 X 3. SP = 2.6 cm  
Carcasa cilíndrica (Dc = 34.5 cm)  
Potencia= 8.6 W/barra. Tamb.= 29 °C

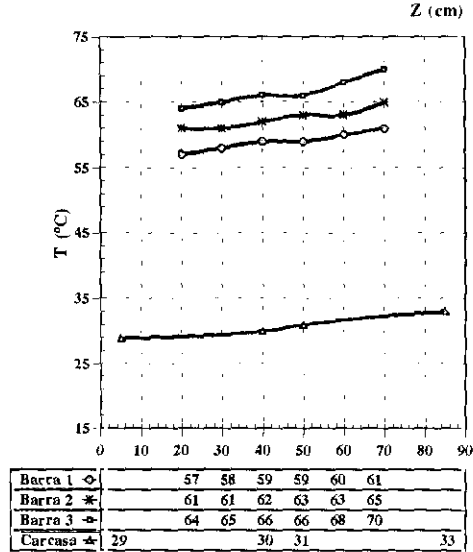

A.2.12. - Configuración 3 X 3. SP = 2.6 cm  
Carcasa cilíndrica (Dc = 34.5 cm)  
Potencia= 18.0 W/barra. Tamb.= 28 °C

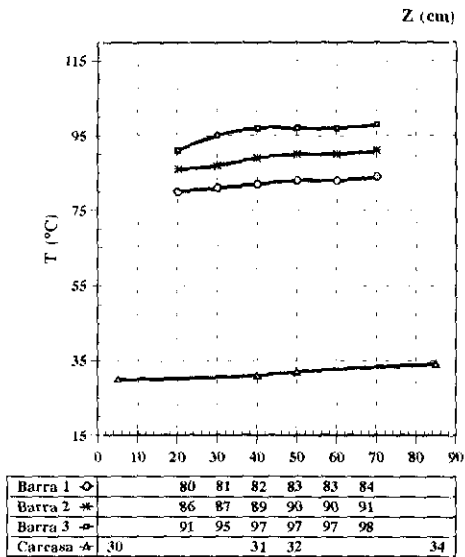

A.2.13. - Configuración 3 X 3. SP = 2.6 cm  
Carcasa cilíndrica (Dc = 34.5 cm)  
Potencia= 32.7 W/barra. Tamb.= 27 °C

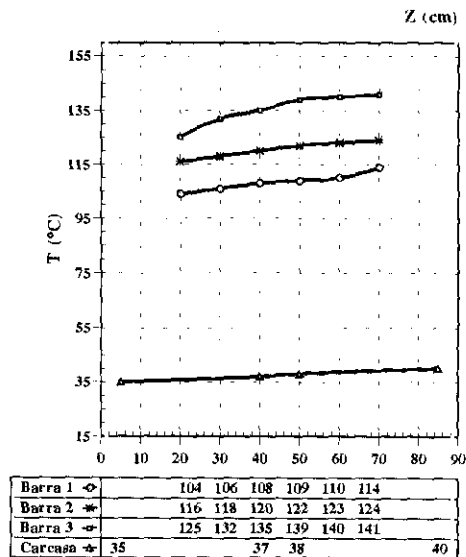



APÉNDICE A : DATOS EXPERIMENTALES

**A.2.14. - Configuración 5 X 5. SP = 2.6 cm**  
**Carcasa cilíndrica (Dc = 17.8 cm)**  
**Potencia= 2.7 W/barra. Tamb.= 22 °C**

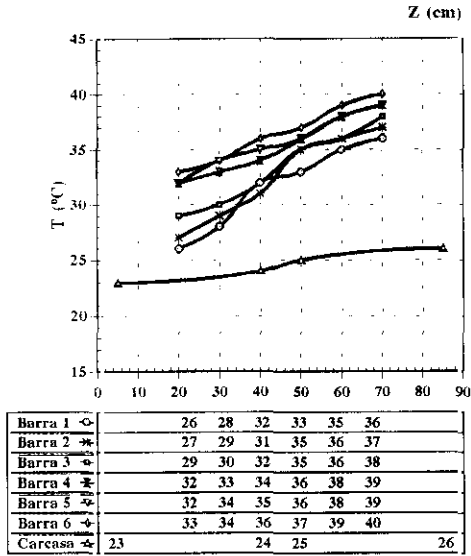

**A.2.15. - Configuración 5 X 5. SP = 2.6 cm**  
**Carcasa cilíndrica (Dc = 17.8 cm)**  
**Potencia= 8.6 W/barra. Tamb.= 22 °C**

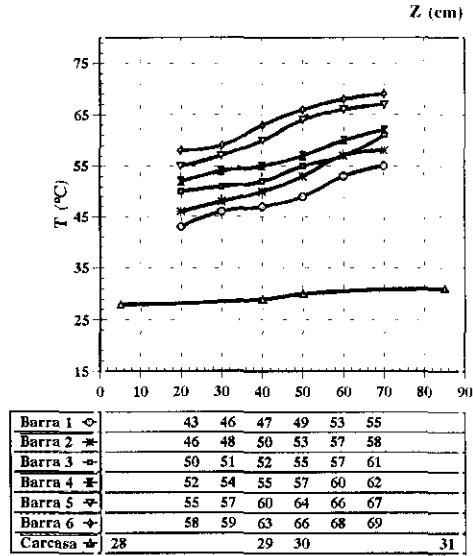

**A.2.16. - Configuración 5 X 5. SP = 2.6 cm**  
**Carcasa cilíndrica (Dc = 17.8 cm)**  
**Potencia= 18.0 W/barra. Tamb.= 22 °C**

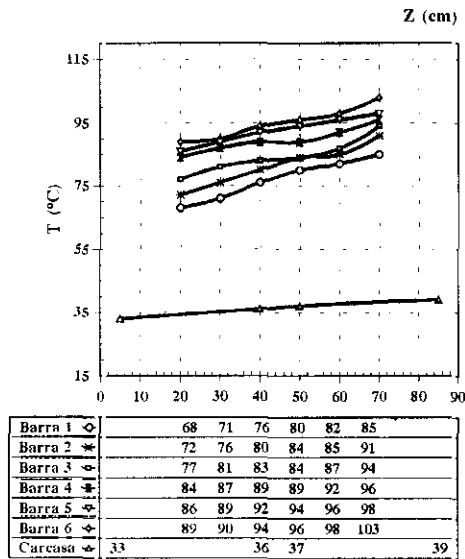

**A.2.17. - Configuración 5 X 5. SP = 2.6 cm**  
**Carcasa cilíndrica (Dc = 17.8 cm)**  
**Potencia= 26.5 W/barra. Tamb.= 21 °C**

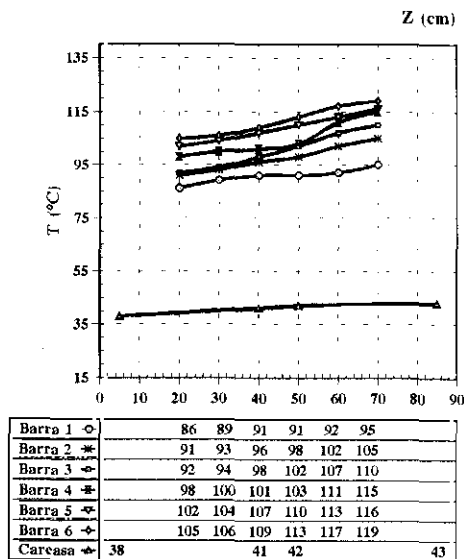

APÉNDICE A : DATOS EXPERIMENTALES

**A.2.18. - Configuración 5 X 5. SP = 2.6 cm**  
**Carcasa cilíndrica (Dc = 34.5 cm)**  
 Potencia= 2.7 W/barra. Tamb.= 20 °C

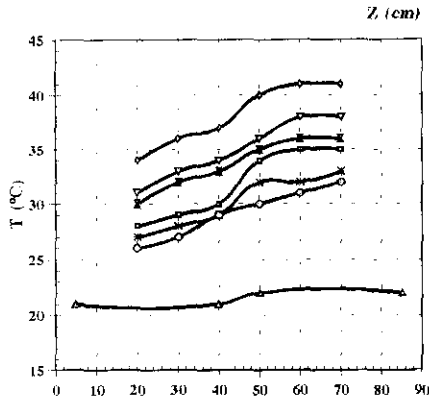

Barra 1 ◊	26	27	29	30	31	32
Barra 2 *	27	28	29	32	32	33
Barra 3 →	28	29	30	34	35	35
Barra 4 ✦	30	32	33	35	36	36
Barra 5 ▽	31	33	34	36	38	38
Barra 6 ⇨	34	36	37	40	41	41
Carcasa ☆	21		21	22		22

**A.2.19. - Configuración 5 X 5. SP = 2.6 cm**  
**Carcasa cilíndrica (Dc = 34.5 cm)**  
 Potencia= 8.6 W/barra. Tamb.= 22 °C

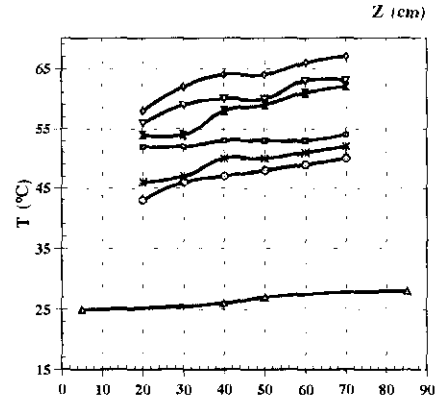

Barra 1 ◊	43	46	47	48	49	50
Barra 2 *	46	47	50	50	51	52
Barra 3 →	52	52	53	53	53	54
Barra 4 ✦	54	54	58	59	61	62
Barra 5 ▽	56	59	60	60	63	63
Barra 6 ⇨	58	62	64	64	66	67
Carcasa ☆	25		26	27		28

**A.2.20. - Configuración 5 X 5. SP = 2.6 cm**  
**Carcasa cilíndrica (Dc = 34.5 cm)**  
 Potencia= 18.0 W/barra. Tamb.= 21 °C

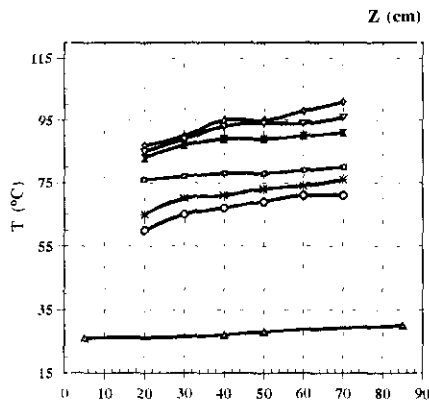

Barra 1 ◊	60	65	67	69	71	71
Barra 2 *	65	70	71	73	74	76
Barra 3 →	76	77	78	78	79	80
Barra 4 ✦	83	87	89	89	90	91
Barra 5 ▽	85	89	93	94	94	96
Barra 6 ⇨	87	90	95	95	98	101
Carcasa ☆	26		27	28		30

**A.2.21. - Configuración 5 X 5. SP = 2.6 cm**  
**Carcasa cilíndrica (Dc = 34.5 cm)**  
 Potencia= 26.5 W/barra. Tamb.= 22 °C

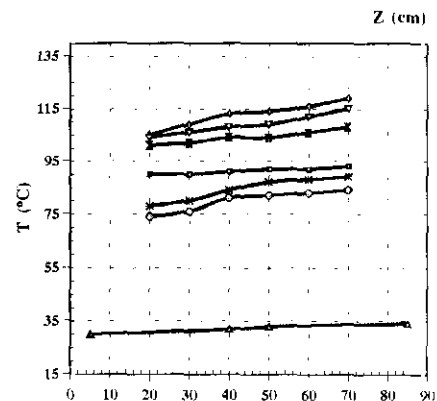

Barra 1 ◊	74	76	81	82	83	84
Barra 2 *	78	80	84	87	88	89
Barra 3 →	90	90	91	92	92	93
Barra 4 ✦	101	102	104	104	106	108
Barra 5 ▽	104	106	108	109	112	115
Barra 6 ⇨	105	109	113	114	116	119
Carcasa ☆	30		32	33		34

APÉNDICE A : DATOS EXPERIMENTALES

A.2.22. - Configuración 5 X 5, SP = 2.6 cm  
Carcasa cilíndrica (Dc = 50.9 cm)  
Potencia= 2.7 W/barra. Tamb.= 21 °C

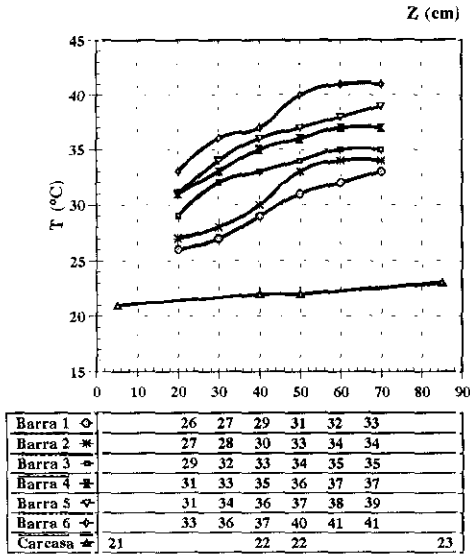

A.2.23. - Configuración 5 X 5, SP = 2.6 cm  
Carcasa cilíndrica (Dc = 50.9 cm)  
Potencia= 8.6 W/barra. Tamb.= 22 °C

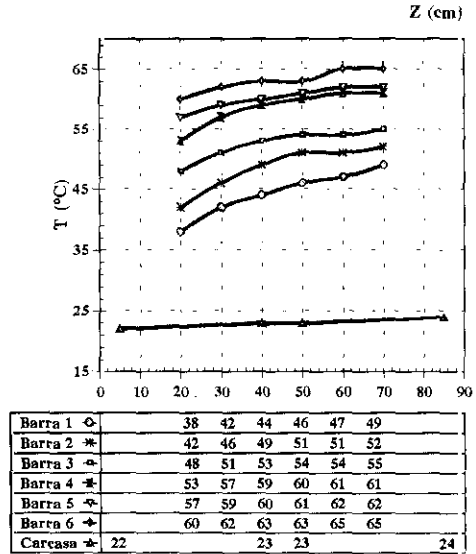

A.2.24. - Configuración 5 X 5, SP = 2.6 cm  
Carcasa cilíndrica (Dc = 50.9 cm)  
Potencia= 18.0 W/barra. Tamb.= 22 °C

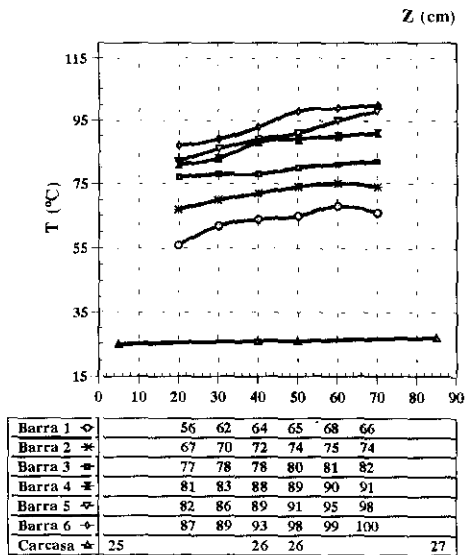

A.2.25. - Configuración 5 X 5, SP = 2.6 cm  
Carcasa cilíndrica (Dc = 50.9 cm)  
Potencia= 26.5 W/barra. Tamb.= 23 °C

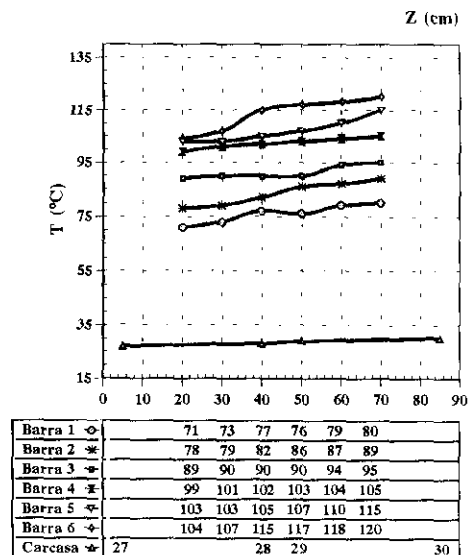

**A.3.- Carcasa cilíndrica. Espaciado de 2.08 cm**

**A.3.1. - Configuración 3 X 3. SP = 2.08 cm**  
 Carcasa cilíndrica (Dc = 10.4 cm)  
 Potencia= 2.7 W/barra. Tamb.= 28 °C

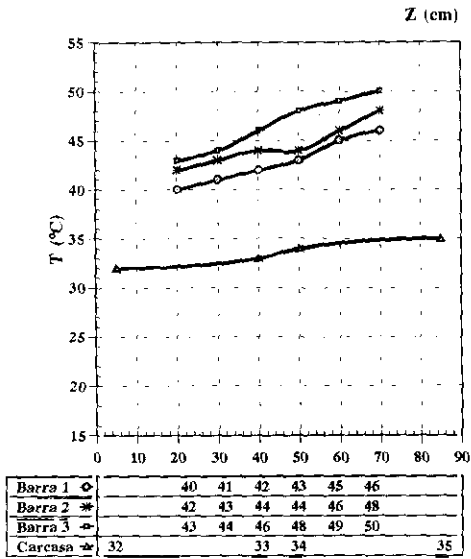

**A.3.2. - Configuración 3 X 3. SP = 2.08 cm**  
 Carcasa cilíndrica (Dc = 10.4 cm)  
 Potencia= 5.7 W/barra. Tamb.= 28 °C

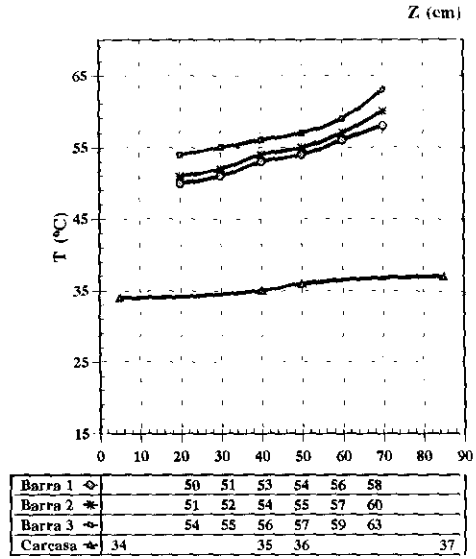

**A.3.3. - Configuración 3 X 3. SP = 2.08 cm**  
 Carcasa cilíndrica (Dc = 10.4 cm)  
 Potencia= 8.6 W/barra. Tamb.= 29 °C

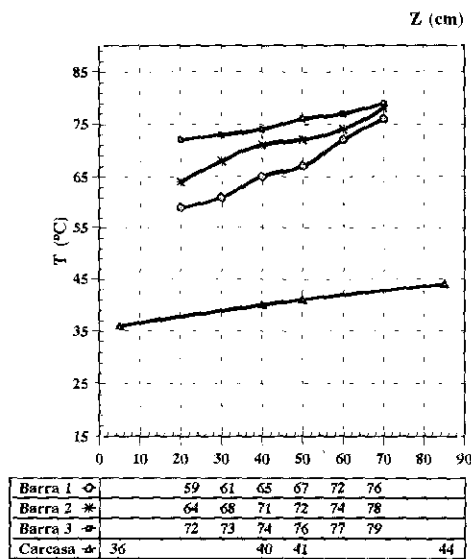

**A.3.4. - Configuración 3 X 3. SP = 2.08 cm**  
 Carcasa cilíndrica (Dc = 10.4 cm)  
 Potencia= 18.0 W/barra. Tamb.= 28 °C

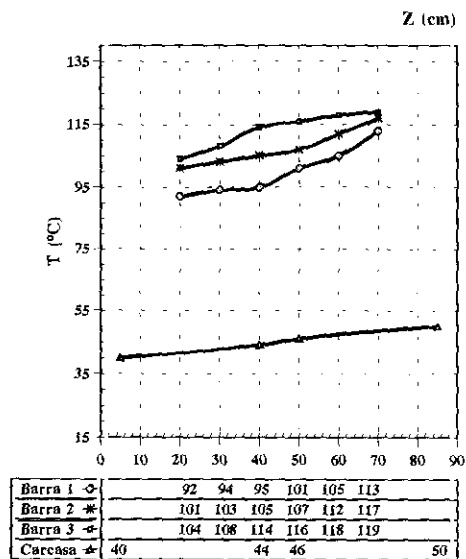

**A.3.5. - Configuración 3 X 3. SP = 2.08 cm**  
 Carcasa cilíndrica (Dc = 10.4 cm)  
 Potencia = 32.7 W/barra. Tamb.= 28 °C

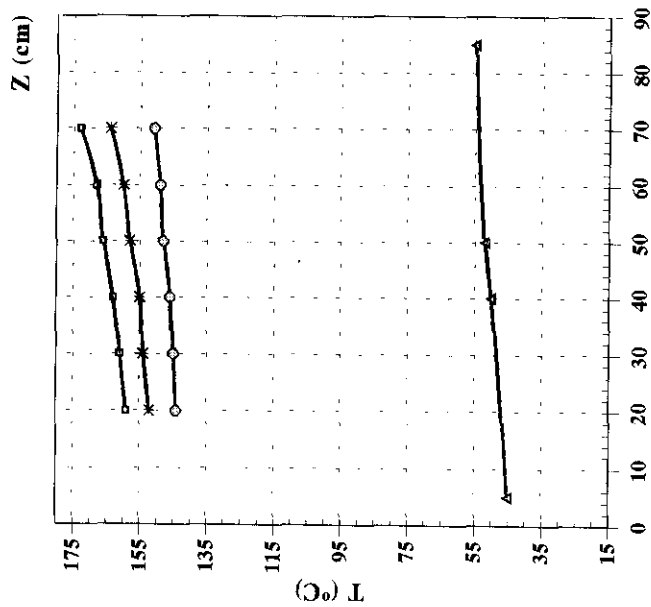

Barra 1 ○	144	145	146	148	149	151
Barra 2 *	152	154	155	158	160	164
Barra 3 □	159	161	163	166	168	173
Carcasa ▲	45	50	52			55

**A.3.6. - Configuración 3 X 3. SP = 2.08 cm**  
 Carcasa cilíndrica (Dc = 10.4 cm)  
 Potencia = 53.7 W/barra. Tamb.= 28 °C

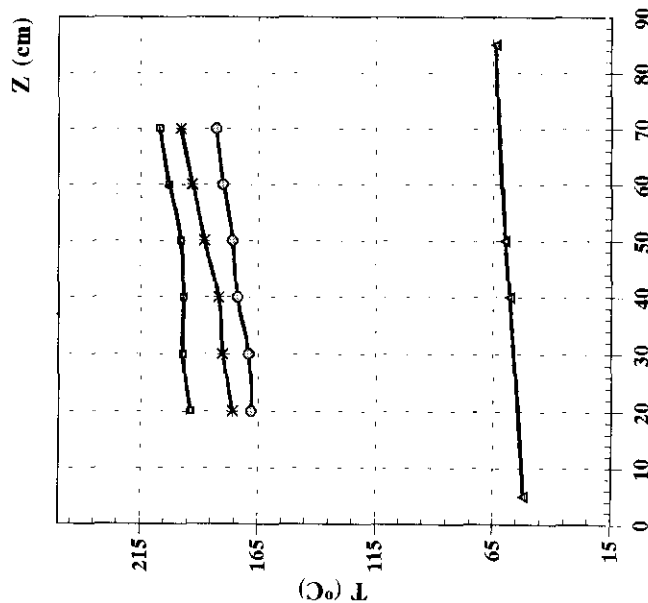

Barra 1 ○	168	169	174	176	180	183
Barra 2 *	176	180	182	188	193	198
Barra 3 □	194	197	197	198	203	207
Carcasa ▲	52	58	60			64

APÉNDICE A : DATOS EXPERIMENTALES

**A.3.7. - Configuración 3 X 3. SP = 2.08 cm**  
 Carcasa cilíndrica (Dc = 17.8 cm)  
 Potencia= 2.7 W/barra. Tamb.= 24 °C

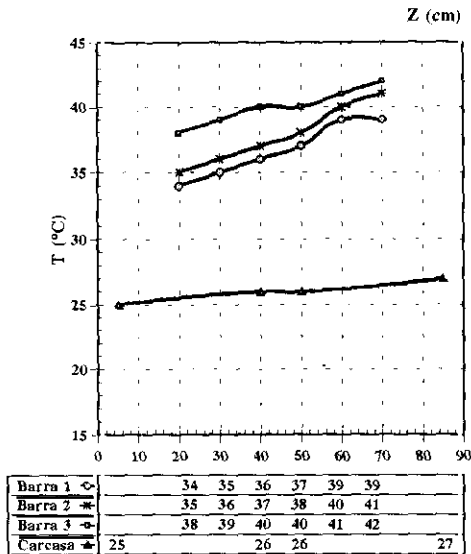

**A.3.8. - Configuración 3 X 3. SP = 2.08 cm**  
 Carcasa cilíndrica (Dc = 17.8 cm)  
 Potencia= 8.6 W/barra. Tamb.= 26 °C

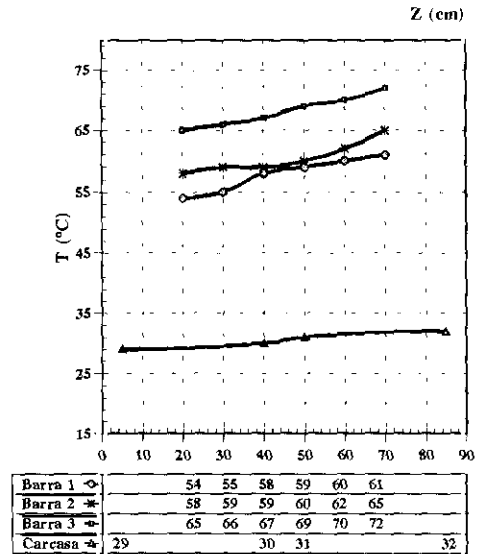

**A.3.9. - Configuración 3 X 3. SP = 2.08 cm**  
 Carcasa cilíndrica (Dc = 17.8 cm)  
 Potencia= 18.0 W/barra. Tamb.= 26 °C

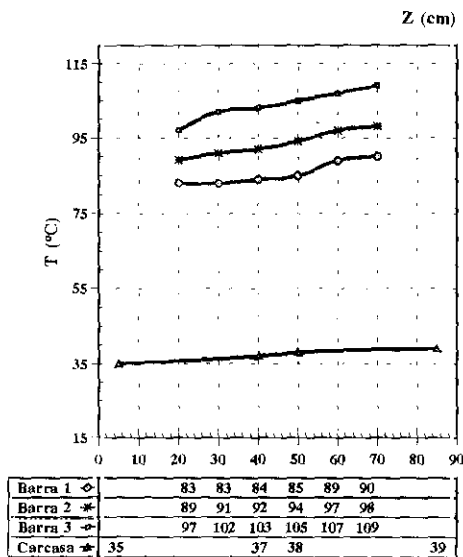

**A.3.10. - Configuración 3 X 3. SP = 2.08 cm**  
 Carcasa cilíndrica (Dc = 17.8 cm)  
 Potencia= 32.7 W/barra. Tamb.= 28 °C

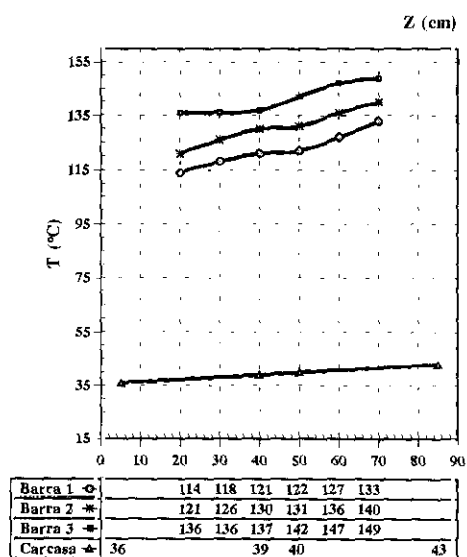

APÉNDICE A : DATOS EXPERIMENTALES

**A.3.11. - Configuración 3 X 3. SP = 2.08 cm**  
 Carcasa cilíndrica (Dc = 34.5 cm)  
 Potencia= 2.7 W/barra. Tamb.= 27 °C

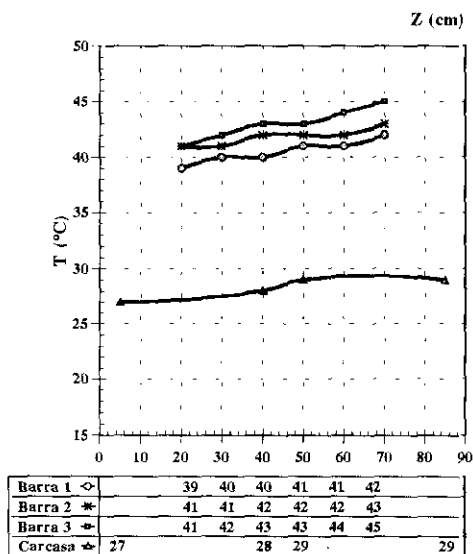

**A.3.12. - Configuración 3 X 3. SP = 2.08 cm**  
 Carcasa cilíndrica (Dc = 34.5 cm)  
 Potencia= 8.6 W/barra. Tamb.= 25 °C

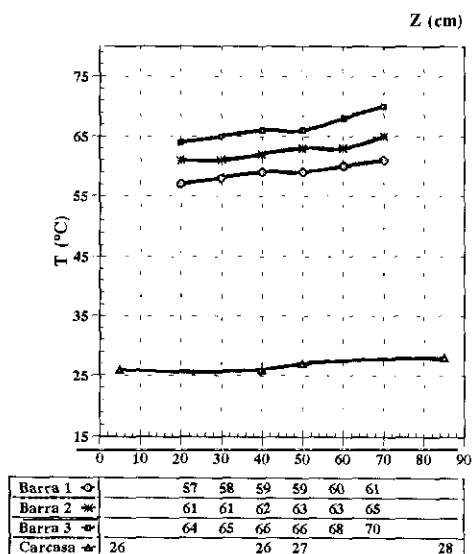

**A.3.13. - Configuración 3 X 3. SP = 2.08 cm**  
 Carcasa cilíndrica (Dc = 34.5 cm)  
 Potencia= 18.0 W/barra. Tamb.= 26 °C

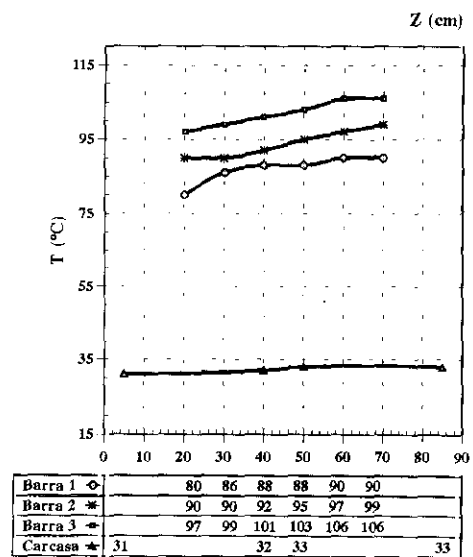

**A.3.14. - Configuración 3 X 3. SP = 2.08 cm**  
 Carcasa cilíndrica (Dc = 34.5 cm)  
 Potencia= 32.7 W/barra. Tamb.= 27 °C

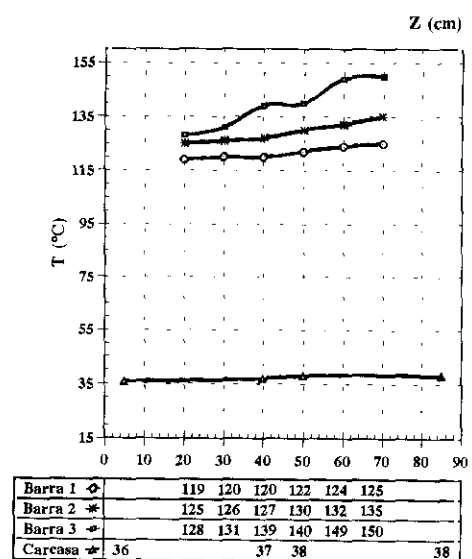

APÉNDICE A : DATOS EXPERIMENTALES

A.3.15. - Configuración 4 X 4. SP = 2.08 cm  
Carcasa cilíndrica (Dc = 17.8 cm)  
Potencia= 3.0 W/barra. Tamb.= 19 °C

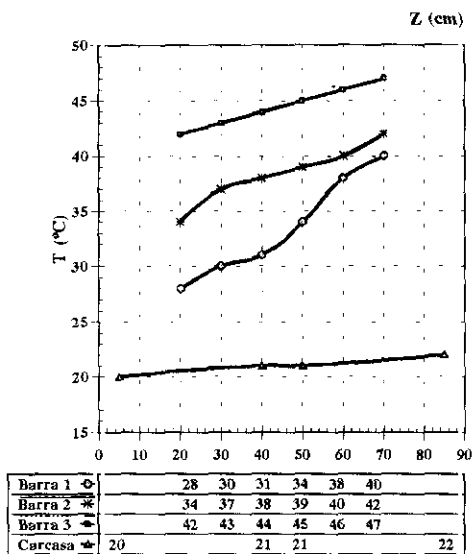

A.3.16. - Configuración 4 X 4. SP = 2.08 cm  
Carcasa cilíndrica (Dc = 17.8 cm)  
Potencia= 9.7 W/barra. Tamb.= 21 °C

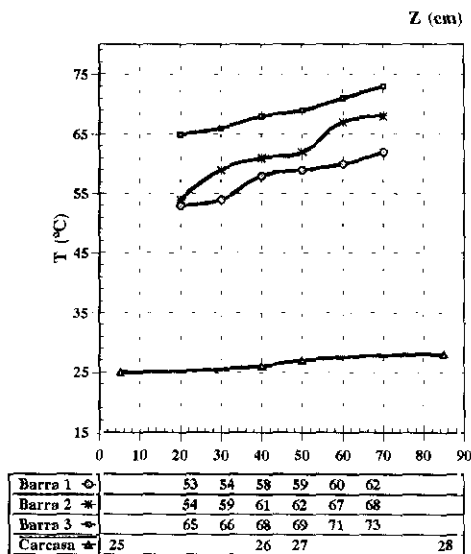

A.3.17. - Configuración 4 X 4. SP = 2.08 cm  
Carcasa cilíndrica (Dc = 17.8 cm)  
Potencia= 20.3 W/barra. Tamb.= 21 °C

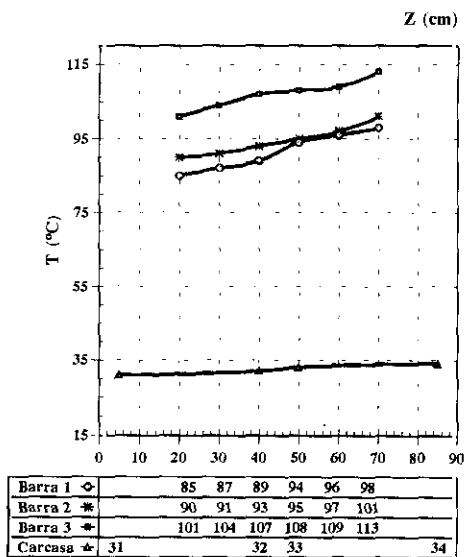

A.3.18. - Configuración 4 X 4. SP = 2.08 cm  
Carcasa cilíndrica (Dc = 17.8 cm)  
Potencia= 27.1 W/barra. Tamb.= 23 °C

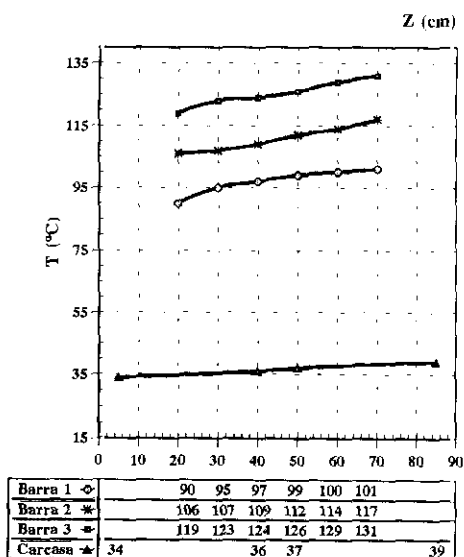



APÉNDICE A : DATOS EXPERIMENTALES

A.3.19. - Configuración 4 X 4. SP = 2.08 cm  
Carcasa cilíndrica (Dc = 34.5 cm)  
Potencia = 3.0 W/barra. Tamb. = 22 °C

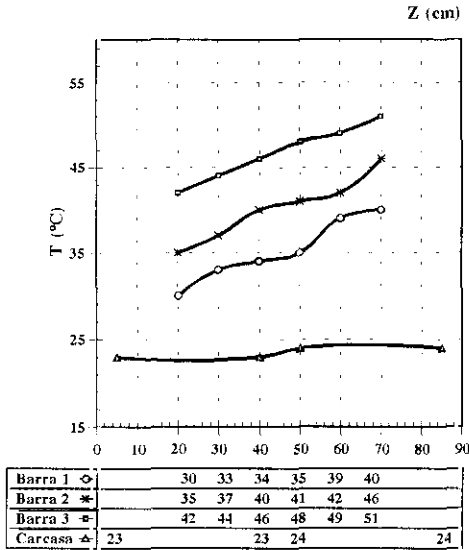

A.3.20. - Configuración 4 X 4. SP = 2.08 cm  
Carcasa cilíndrica (Dc = 34.5 cm)  
Potencia = 9.7 W/barra. Tamb. = 21 °C

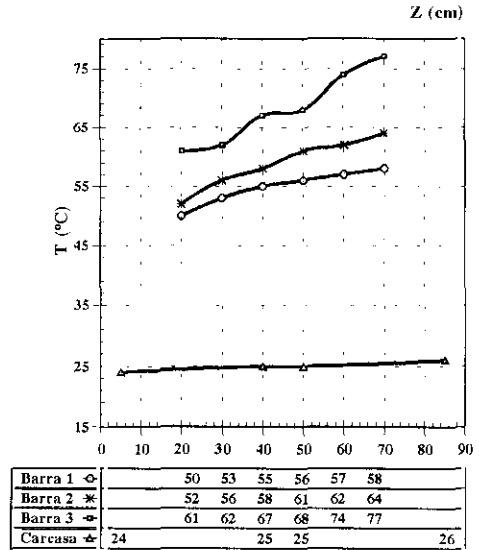

A.3.21. - Configuración 4 X 4. SP = 2.08 cm  
Carcasa cilíndrica (Dc = 34.5 cm)  
Potencia = 20.3 W/barra. Tamb. = 21 °C

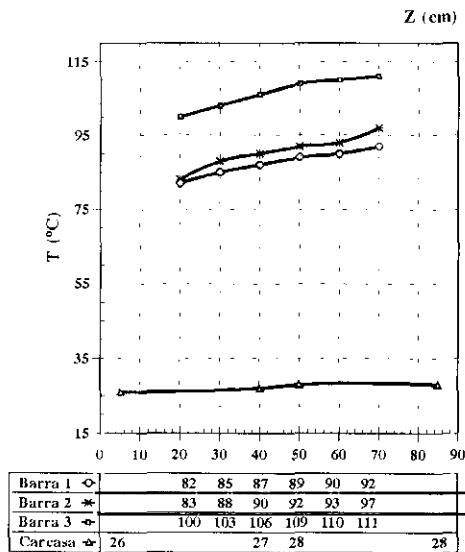

A.3.22. - Configuración 4 X 4. SP = 2.08 cm  
Carcasa cilíndrica (Dc = 34.5 cm)  
Potencia = 27.1 W/barra. Tamb. = 21 °C

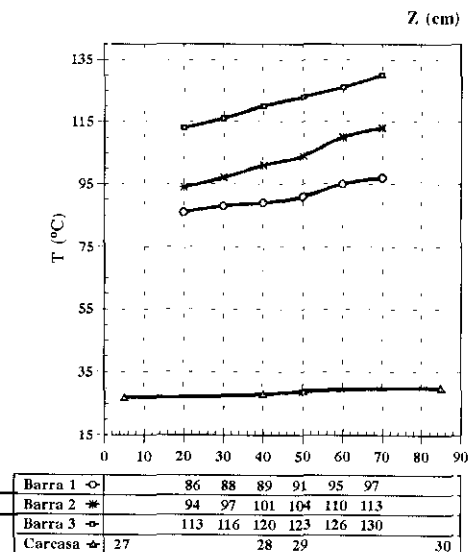

**A.3.23. - Configuración 4 X 4. SP = 2.08 cm**  
**Carcasa cilíndrica (Dc = 50.9 cm)**  
**Potencia= 20.3 W/barra. Tamb.= 22 °C**

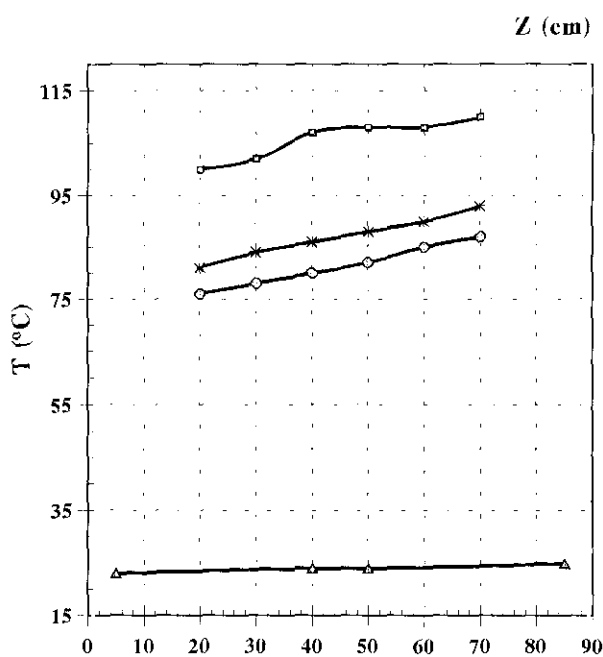

Barra 1 ○	76	78	80	82	85	87
Barra 2 *	81	84	86	88	90	93
Barra 3 □	100	102	107	108	108	110
Carcasa △	23		24	24		25

**A.4.- Carcasa cilíndrica. Espaciado de 1.62 cm**

**A.4.1. - Configuración 3 X 3. SP = 1.62 cm**  
 Carcasa cilíndrica (Dc = 10.4 cm)  
 Potencia= 2.7 W/barra. Tamb.= 23 °C

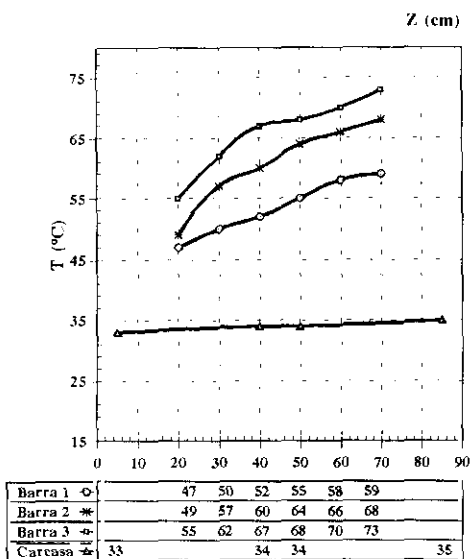

**A.4.2. - Configuración 3 X 3. SP = 1.62 cm**  
 Carcasa cilíndrica (Dc = 10.4 cm)  
 Potencia= 8.6 W/barra. Tamb.= 24 °C

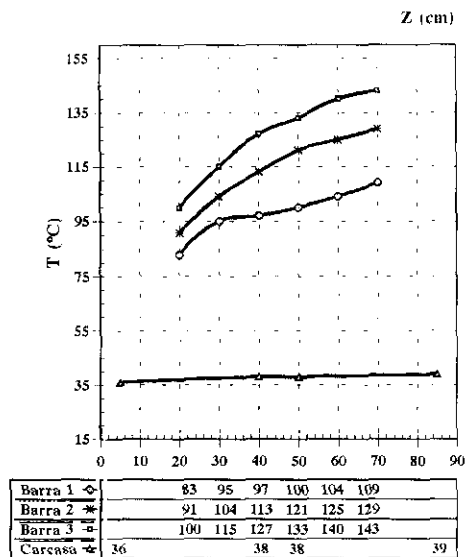

**A.4.3. - Configuración 3 X 3. SP = 1.62 cm**  
 Carcasa cilíndrica (Dc = 10.4 cm)  
 Potencia= 18.0 W/barra. Tamb.= 23 °C

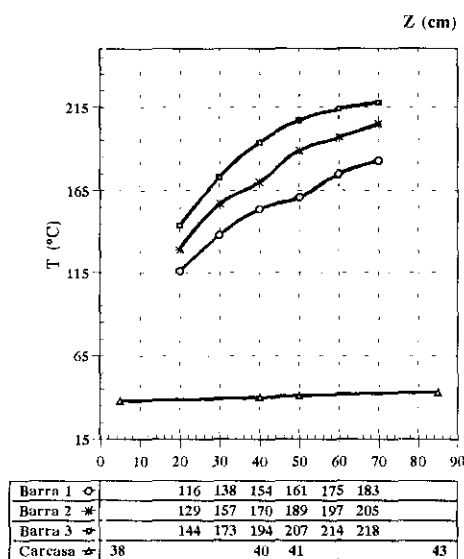

**A.4.4. - Configuración 3 X 3. SP = 1.62 cm**  
 Carcasa cilíndrica (Dc = 10.4 cm)  
 Potencia= 32.7 W/barra. Tamb.= 21 °C

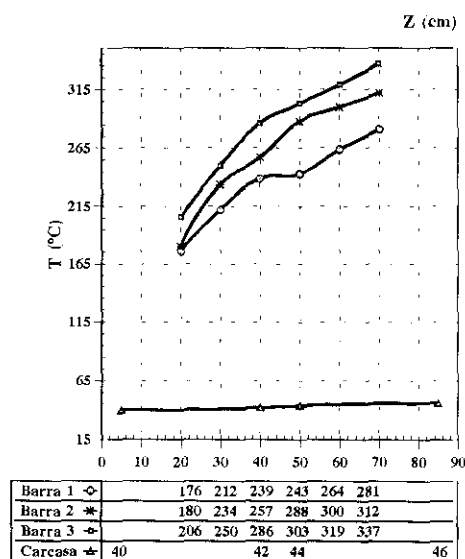

**A.4.5. - Configuración 3 X 3. SP = 1.62 cm**  
**Carcasa cilíndrica (Dc = 10.4 cm)**  
**Potencia= 45.0 W/barra. Tamb.= 20 °C**

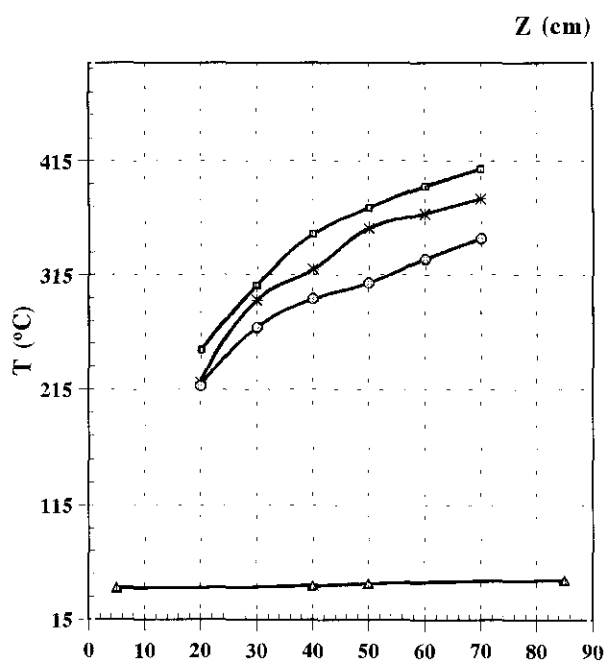

Barra 1 ◯	218	269	294	308	329	347
Barra 2 *	221	293	320	356	369	382
Barra 5 ◻	249	306	351	374	393	408
Carcasa ◻	43		45	47		50

APÉNDICE A : DATOS EXPERIMENTALES

A.4.6. - Configuración 3 X 3. SP = 1.62 cm  
Carcasa cilíndrica (Dc = 17.8 cm)  
Potencia= 2.7 W/barra. Tamb.= 20 °C

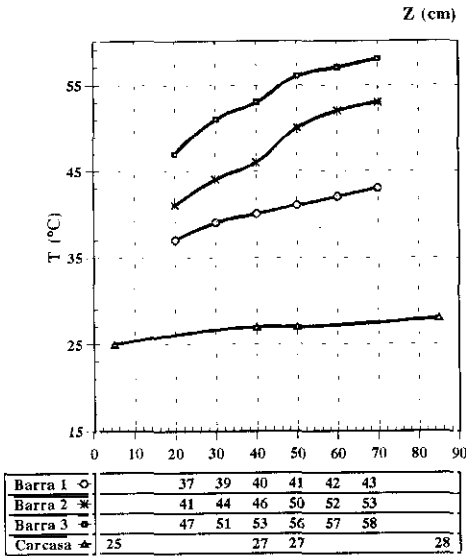

A.4.7. - Configuración 3 X 3. SP = 1.62 cm  
Carcasa cilíndrica (Dc = 17.8 cm)  
Potencia= 8.6 W/barra. Tamb.= 20 °C

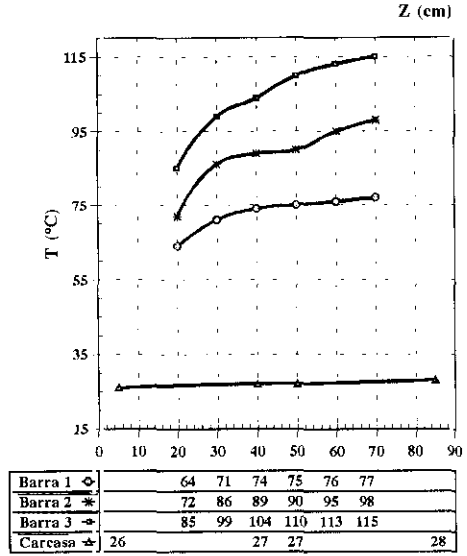

A.4.8. - Configuración 3 X 3. SP = 1.62 cm  
Carcasa cilíndrica (Dc = 17.8 cm)  
Potencia= 18.0 W/barra. Tamb.= 21 °C

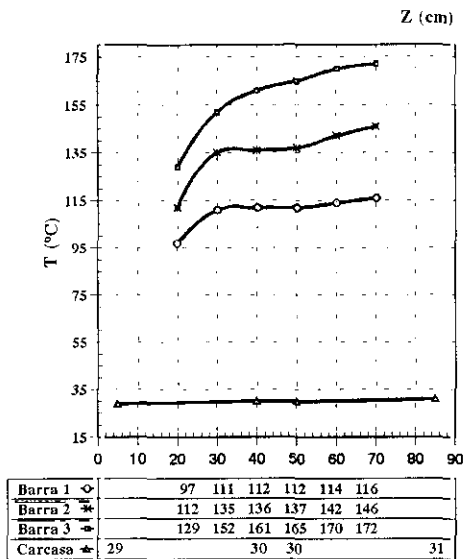

A.4.9. - Configuración 3 X 3. SP = 1.62 cm  
Carcasa cilíndrica (Dc = 17.8 cm)  
Potencia= 32.7 W/barra. Tamb.= 20 °C

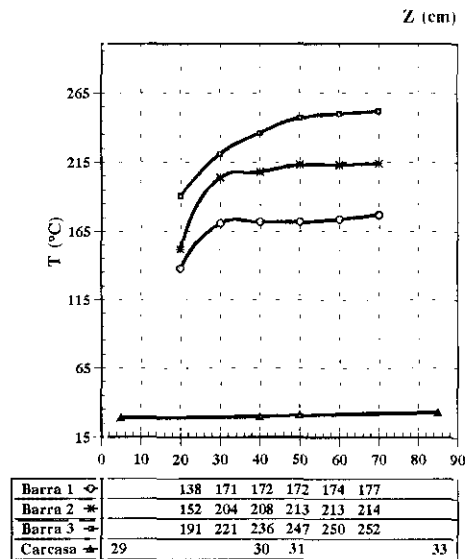

**A.4.10. - Configuración 3 X 3. SP = 1.62 cm**  
**Carcasa cilíndrica (Dc = 17.8 cm)**  
**Potencia= 45.0 W/barra. Tamb.= 23 °C**

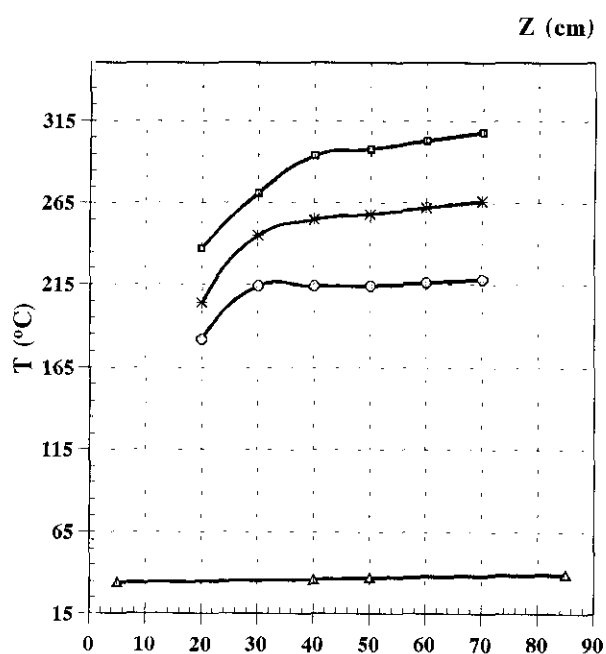

Barra 1 ◊	182	214	214	214	216	218
Barra 2 *	204	245	255	258	262	266
Barra 3 ◻	237	271	294	298	303	308
Carcasa ▲	34		36	37		39

APÉNDICE A : DATOS EXPERIMENTALES

A.4.11. - Configuración 3 X 3. SP = 1.62 cm  
Carcasa cilíndrica (Dc = 34.5 cm)  
Potencia= 2.7 W/barra. Tamb.= 21 °C

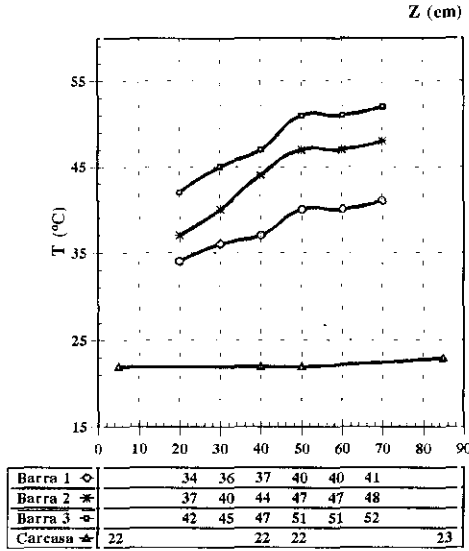

A.4.12. - Configuración 3 X 3. SP = 1.62 cm  
Carcasa cilíndrica (Dc = 34.5 cm)  
Potencia= 8.6 W/barra. Tamb.= 21 °C

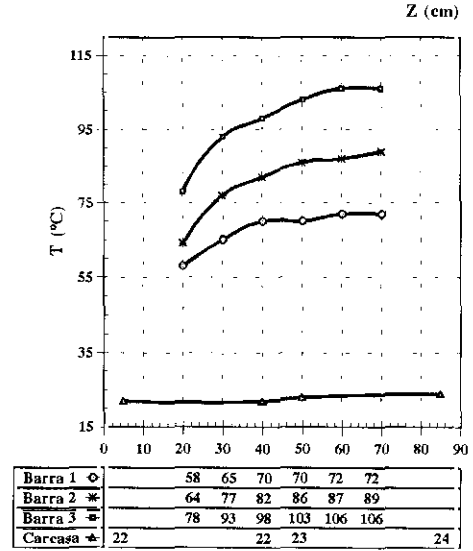

A.4.13. - Configuración 3 X 3. SP = 1.62 cm  
Carcasa cilíndrica (Dc = 34.5 cm)  
Potencia= 18.0 W/barra. Tamb.= 22 °C

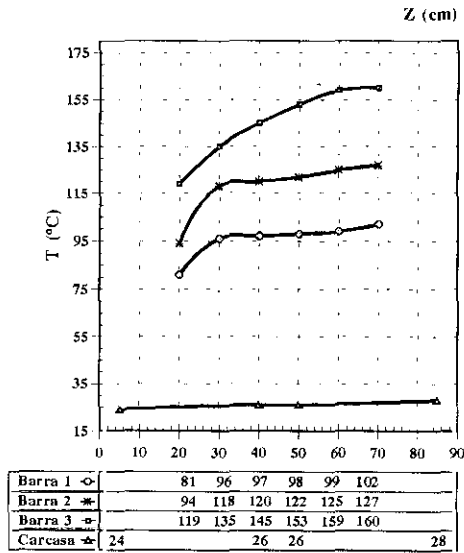

A.4.14. - Configuración 3 X 3. SP = 1.62 cm  
Carcasa cilíndrica (Dc = 34.5 cm)  
Potencia= 32.7 W/barra. Tamb.= 23 °C

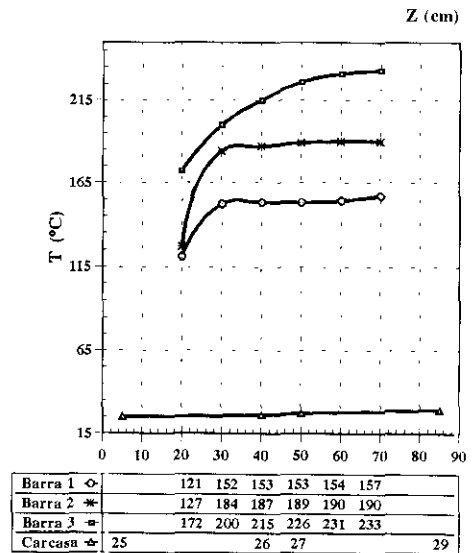

**A.4.15. - Configuración 3 X 3. SP = 1.62 cm**  
**Carcasa cilíndrica (Dc = 34.5 cm)**  
**Potencia= 45.0 W/barra. Tamb.= 23 °C**

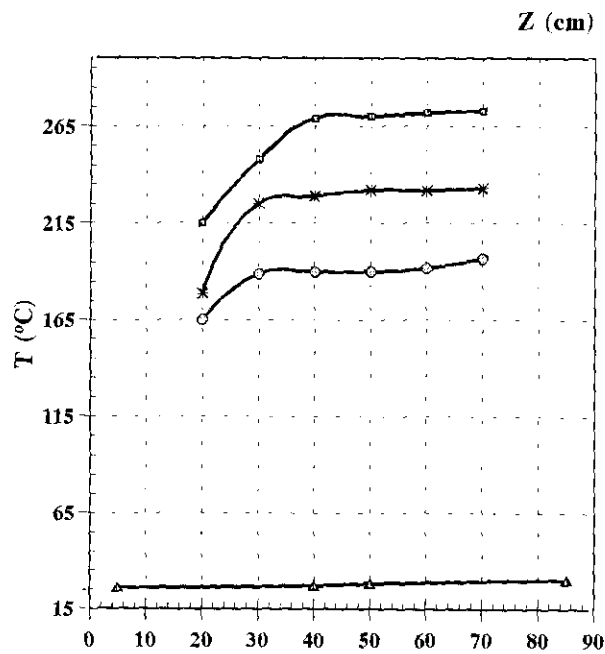

Barra 1 ◯	165	189	190	190	192	197
Barra 2 *	179	225	229	232	232	233
Barra 3 ◻	215	248	269	270	272	273
Carcasa ◄	26		27	28		30



APÉNDICE A : DATOS EXPERIMENTALES

A.4.16. - Configuración 4 X 4. SP = 1.62 cm  
Carcasa cilíndrica (Dc = 17.8 cm)  
Potencia= 1.8 W/barra. Tamb.=22 °C

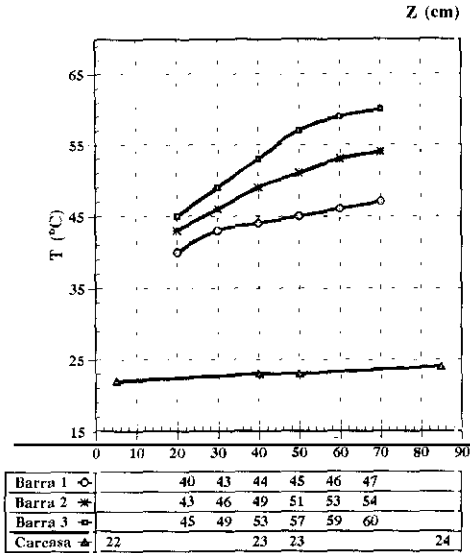

A.4.17. - Configuración 4 X 4. SP = 1.62 cm  
Carcasa cilíndrica (Dc = 17.8 cm)  
Potencia= 2.7 W/barra. Tamb.= 21 °C

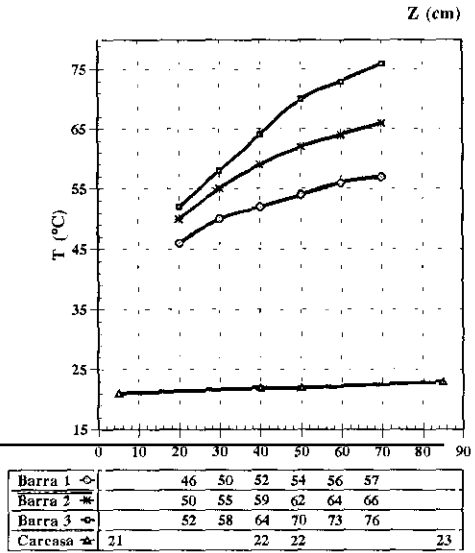

A.4.18. - Configuración 4 X 4. SP = 1.62 cm  
Carcasa cilíndrica (Dc = 17.8 cm)  
Potencia= 3.6 W/barra. Tamb.= 22 °C

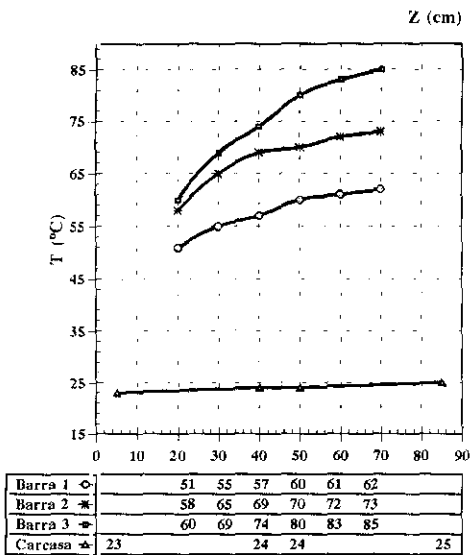

A.4.19. - Configuración 4 X 4. SP = 1.62 cm  
Carcasa cilíndrica (Dc = 17.8 cm)  
Potencia= 4.5 W/barra. Tamb.= 22 °C

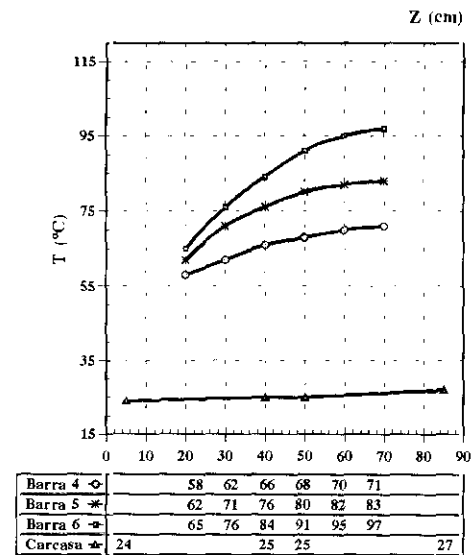

**A.4.20. - Configuración 4 X 4. SP = 1.62 cm**  
**Carcasa cilíndrica (Dc = 17.8 cm)**  
**Potencia= 5.4 W/barra. Tamb.= 22 °C**

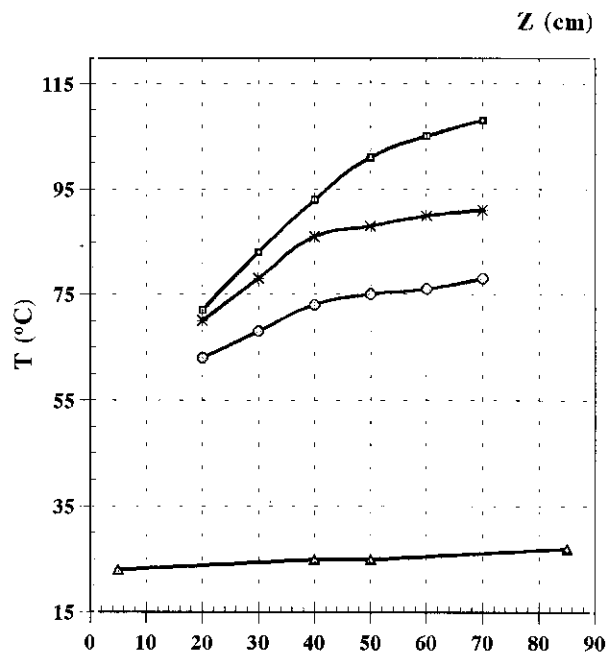

Barra 1 ◊	63	68	73	75	76	78
Barra 2 *	70	78	86	88	90	91
Barra 3 ◻	72	83	93	101	105	108
Carcasa △	23		25	25		27

APÉNDICE A : DATOS EXPERIMENTALES

A.4.21. - Configuración 4 X 4, SP = 1.62 cm  
Carcasa cilíndrica (Dc = 34.5 cm)  
Potencia= 1.8 W/barra. Tamb.= 21 °C

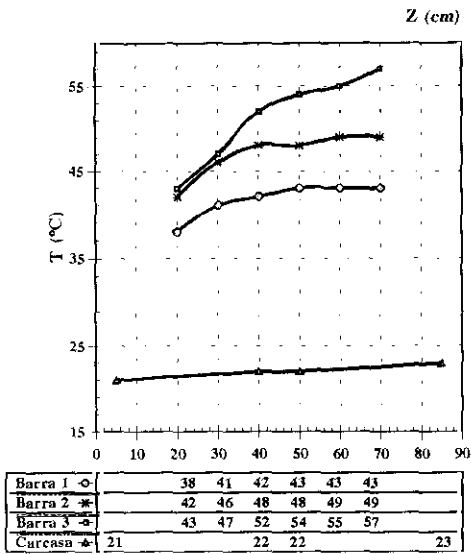

A.4.22. - Configuración 4 X 4, SP = 1.62 cm  
Carcasa cilíndrica (Dc = 34.5 cm)  
Potencia= 2.7 W/barra. Tamb.= 20 °C

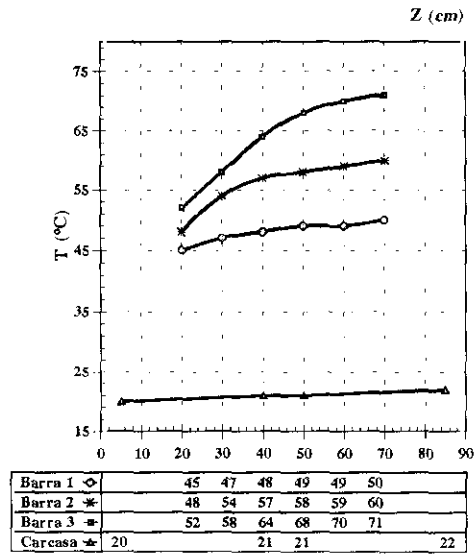

A.4.23. - Configuración 4 X 4, SP = 1.62 cm  
Carcasa cilíndrica (Dc = 34.5 cm)  
Potencia= 3.6 W/barra. Tamb.= 20 °C

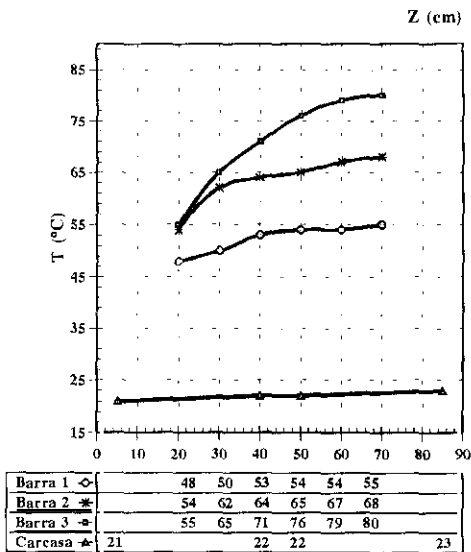

A.4.24. - Configuración 4 X 4, SP = 1.62 cm  
Carcasa cilíndrica (Dc = 34.5 cm)  
Potencia= 4.5 W/barra. Tamb.= 21 °C

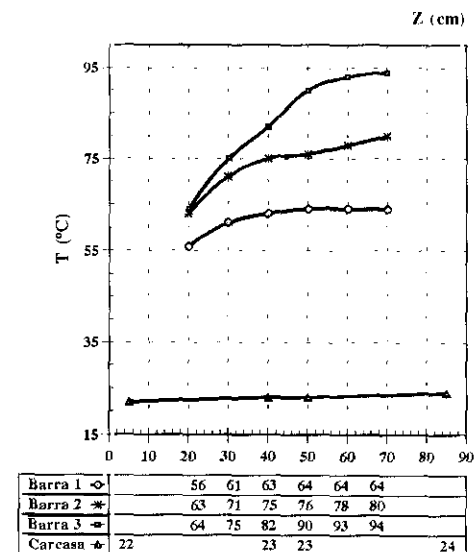

**A.4.25. - Configuración 4 X 4. SP = 1.62 cm**  
**Carcasa cilíndrica (Dc = 34.5 cm)**  
**Potencia= 5.4 W/barra. Tamb.= 21 °C**

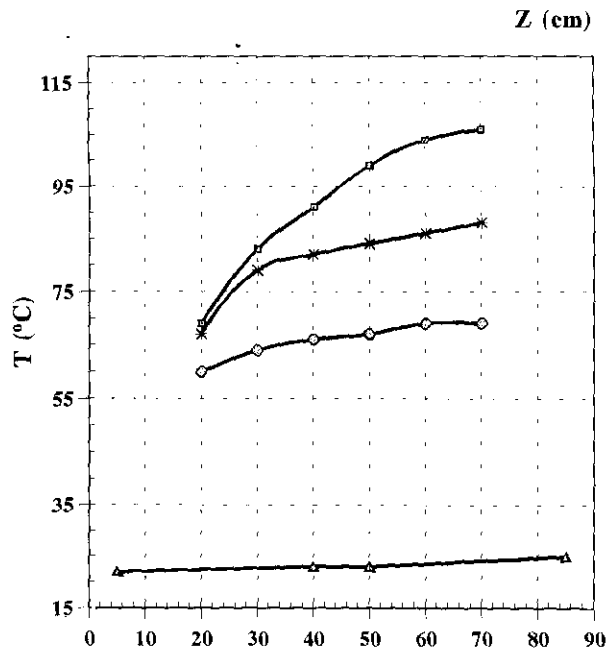

Barra 1 ◊	60	64	66	67	69	69
Barra 2 *	67	79	82	84	86	88
Barra 3 ◻	69	83	91	99	104	106
Carcasa △	22		23	23		25

APÉNDICE A : DATOS EXPERIMENTALES

A.4.26. - Configuración 4 X 4. SP = 1.62 cm  
Carcasa cilíndrica (Dc = 50.9 cm)  
Potencia = 1.8 W/barra. Tamb. = 21 °C

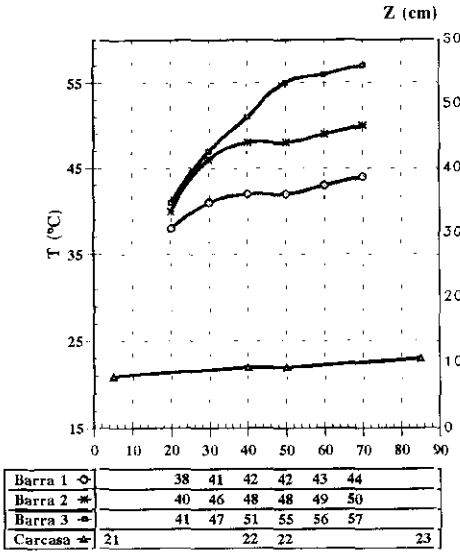

A.4.27. - Configuración 4 X 4. SP = 1.62 cm  
Carcasa cilíndrica (Dc = 50.9 cm)  
Potencia = 2.7 W/barra. Tamb. = 22 °C

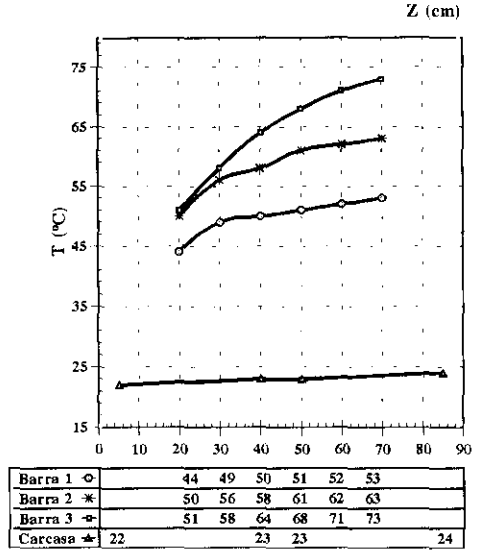

A.4.28. - Configuración 4 X 4. SP = 1.62 cm  
Carcasa cilíndrica (Dc = 50.9 cm)  
Potencia = 3.6 W/barra. Tamb. = 23 °C

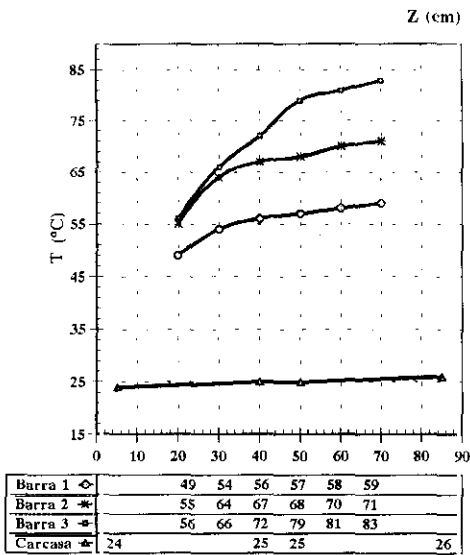

A.4.29. - Configuración 4 X 4. SP = 1.62 cm  
Carcasa cilíndrica (Dc = 50.9 cm)  
Potencia = 4.5 W/barra. Tamb. = 22 °C

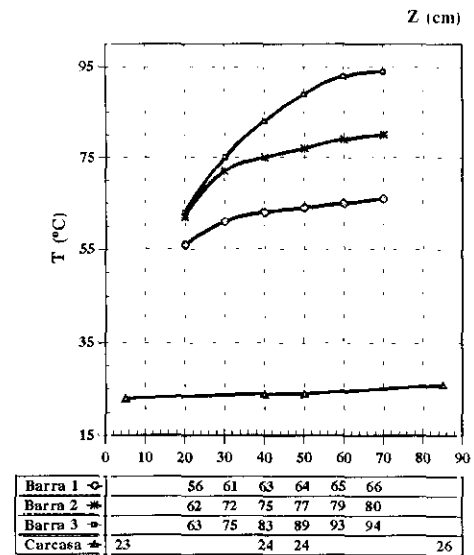

**A.4.30. - Configuración 4 X 4. SP = 1.62 cm**  
**Carcasa cilíndrica (Dc = 50.9 cm)**  
**Potencia= 5.4 W/barra. Tamb.= 24 °C**

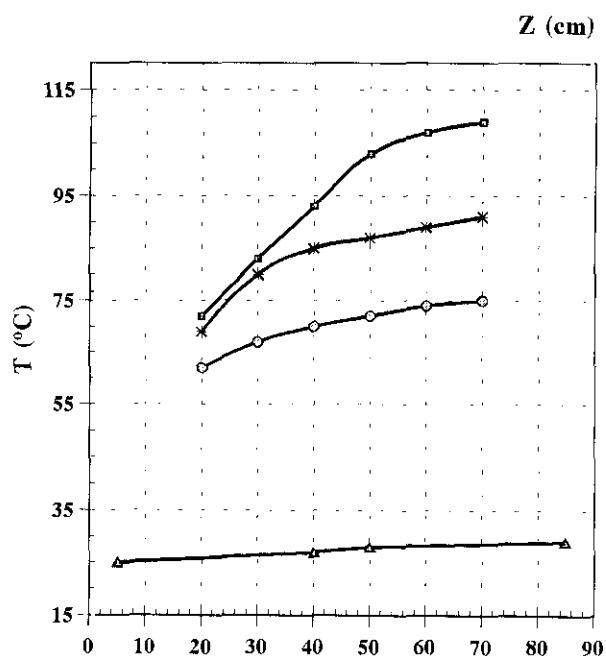

Barra 1 ◊	62	67	70	72	74	75
Barra 2 *	69	80	85	87	89	91
Barra 3 ▣	72	83	93	103	107	109
Carcasa ▲	25		27	28		29

APÉNDICE A : DATOS EXPERIMENTALES

A.4.31. - Configuración 5 X 5. SP = 1.62 cm  
Carcasa cilíndrica (Dc = 17.8 cm)  
Potencia= 2.7 W/barra. Tamb.= 22 °C

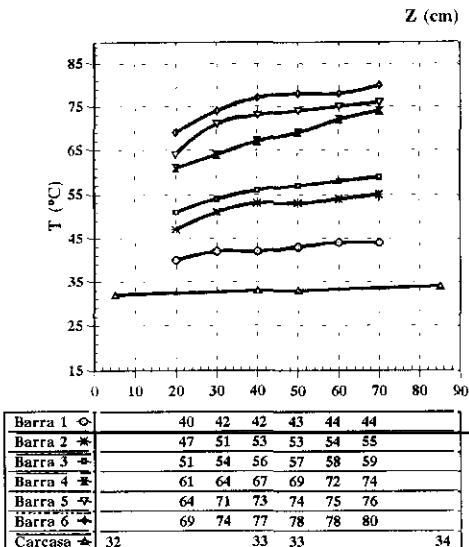

A.4.32. - Configuración 5 X 5. SP = 1.62 cm  
Carcasa cilíndrica (Dc = 17.8 cm)  
Potencia= 8.6 W/barra. Tamb.= 24 °C

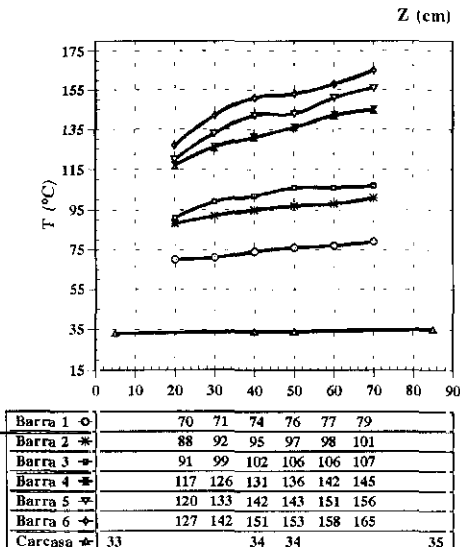

A.4.33. - Configuración 5 X 5. SP = 1.62 cm  
Carcasa cilíndrica (Dc = 17.8 cm)  
Potencia= 18.0 W/barra. Tamb.= 25 °C

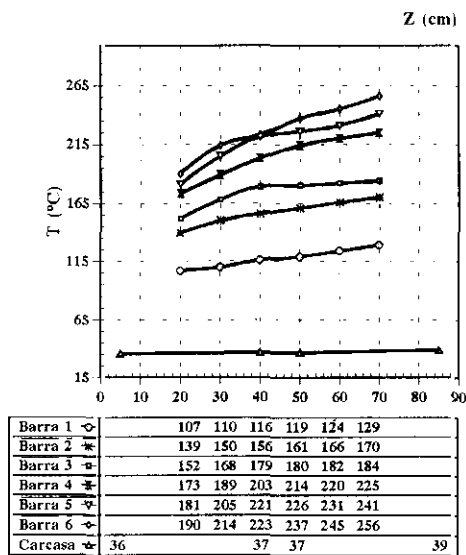

A.4.34. - Configuración 5 X 5. SP = 1.62 cm  
Carcasa cilíndrica (Dc = 17.8 cm)  
Potencia= 32.7 W/barra. Tamb.= 21 °C

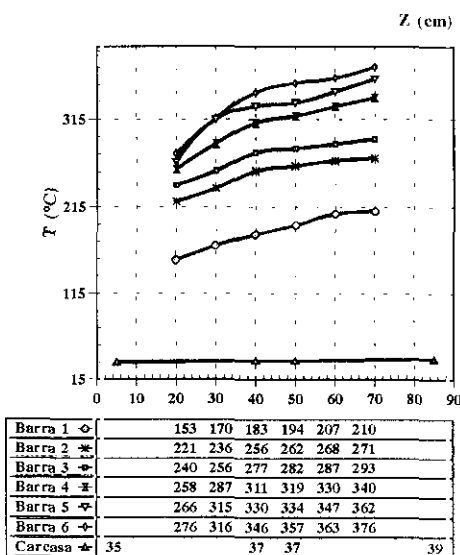

APÉNDICE A : DATOS EXPERIMENTALES

A.4.35. - Configuración 5 X 5. SP = 1.62 cm  
Carcasa cilíndrica (Dc = 34.5 cm)  
Potencia= 2.7 W/barra. Tamb.= 22 °C

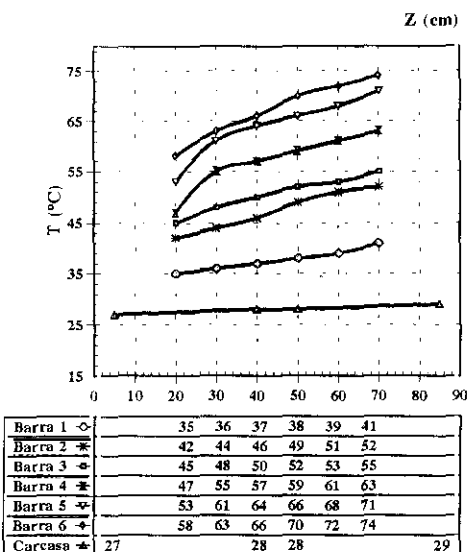

A.4.36. - Configuración 5 X 5. SP = 1.62 cm  
Carcasa cilíndrica (Dc = 34.5 cm)  
Potencia= 8.6 W/barra. Tamb.= 21 °C

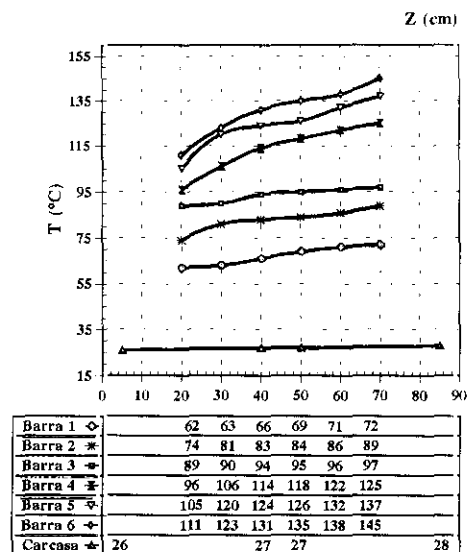

A.4.37. - Configuración 5 X 5. SP = 1.62 cm  
Carcasa cilíndrica (Dc = 34.5 cm)  
Potencia= 18.0 W/barra. Tamb.= 20 °C

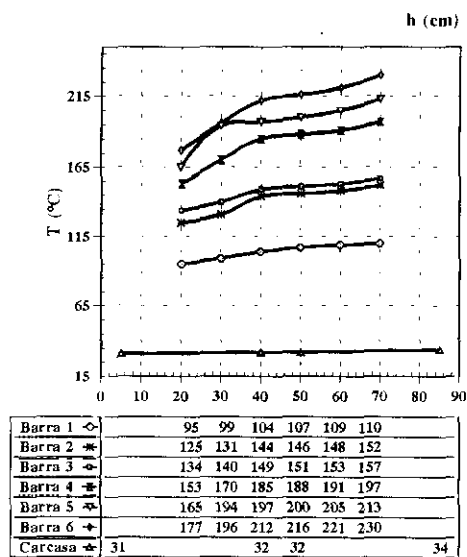

A.4.38. - Configuración 5 X 5. SP = 1.62 cm  
Carcasa cilíndrica (Dc = 34.5 cm)  
Potencia= 32.7 W/barra. Tamb.= 20 °C

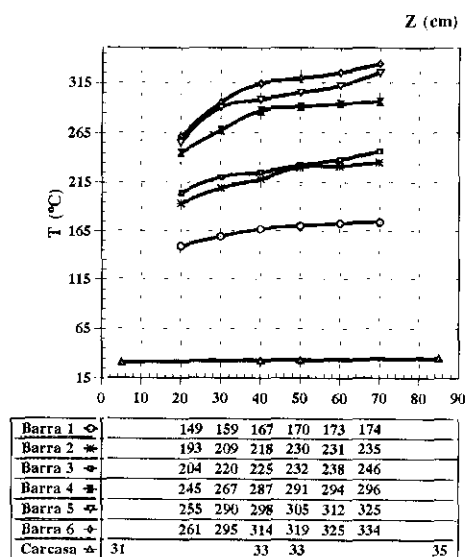



APÉNDICE A : DATOS EXPERIMENTALES

A.4.39. - Configuración 5 X 5. SP = 1.62 cm  
Carcasa cilíndrica (Dc = 50.9 cm)  
Potencia= 2.7 W/barra. Tamb.= 22 °C

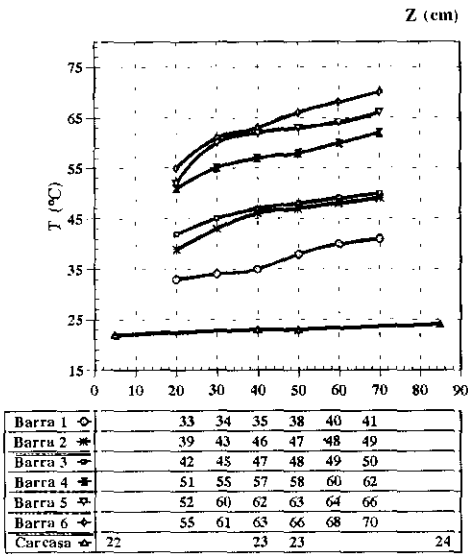

A.4.40. - Configuración 5 X 5. SP = 1.62 cm  
Carcasa cilíndrica (Dc = 50.9 cm)  
Potencia= 8.6 W/barra. Tamb.= 23 °C

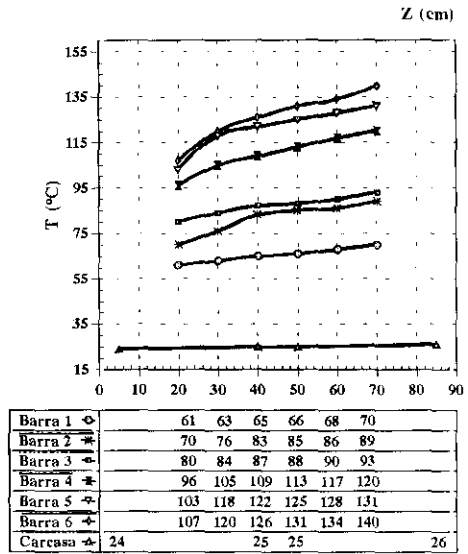

A.4.41. - Configuración 5 X 5. SP = 1.62 cm  
Carcasa cilíndrica (Dc = 50.9 cm)  
Potencia= 18.0 W/barra. Tamb.= 25 °C

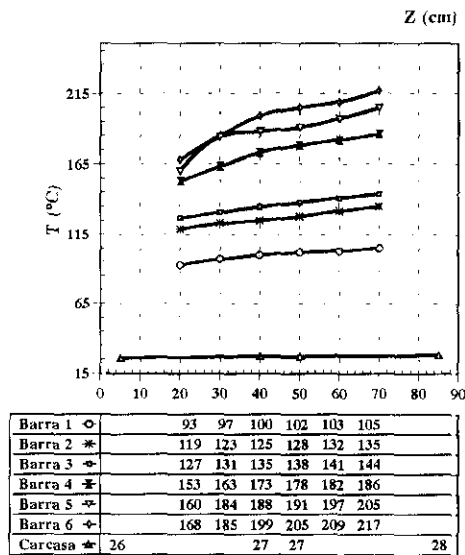

A.4.42. - Configuración 5 X 5. SP = 1.62 cm  
Carcasa cilíndrica (Dc = 50.9 cm)  
Potencia= 32.7 W/barra. Tamb.= 24 °C

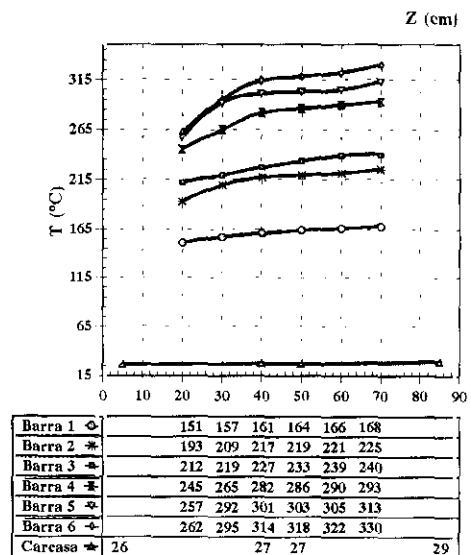

## A.5.- Carcasa cilíndrica. Rejilla central

**A.5.1.- Configuración 4 X 4. Rejilla central**  
 SP = 1.62 cm. Carcasa cilíndrica (Dc = 17.8 cm)  
 Potencia= 1.8 W/barra. Tamb.= 20 °C

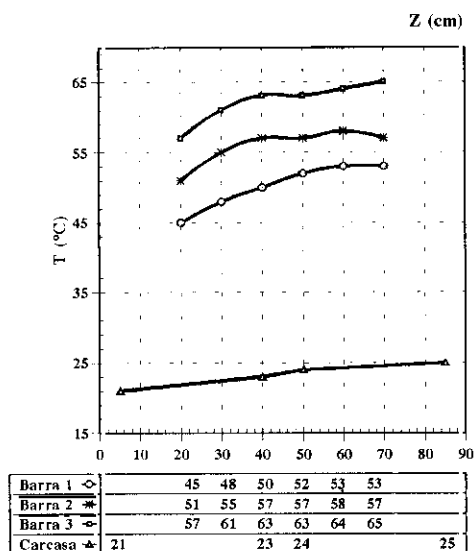

**A.5.2.- Configuración 4 X 4. Rejilla central**  
 SP = 1.62 cm. Carcasa cilíndrica (Dc = 17.8 cm)  
 Potencia= 2.7 W/barra. Tamb.= 20 °C

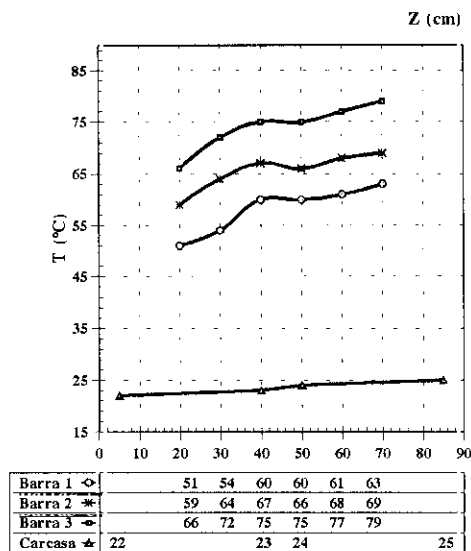

**A.5.3.- Configuración 4 X 4. Rejilla central**  
 SP = 1.62 cm. Carcasa cilíndrica (Dc = 17.8 cm)  
 Potencia= 3.6 W/barra. Tamb.= 21 °C

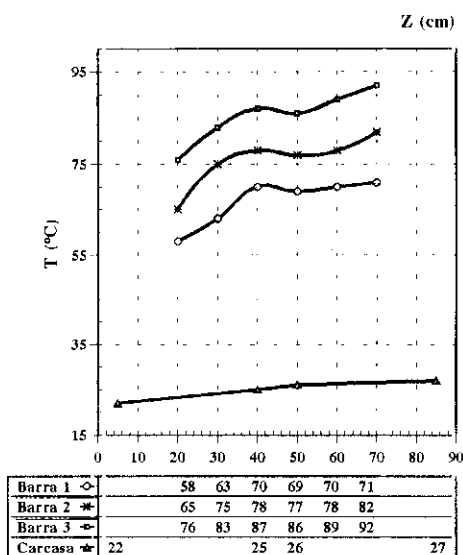

**A.5.4.- Configuración 4 X 4. Rejilla central**  
 SP = 1.62 cm. Carcasa cilíndrica (Dc = 17.8 cm)  
 Potencia= 4.5 W/barra. Tamb.= 21 °C

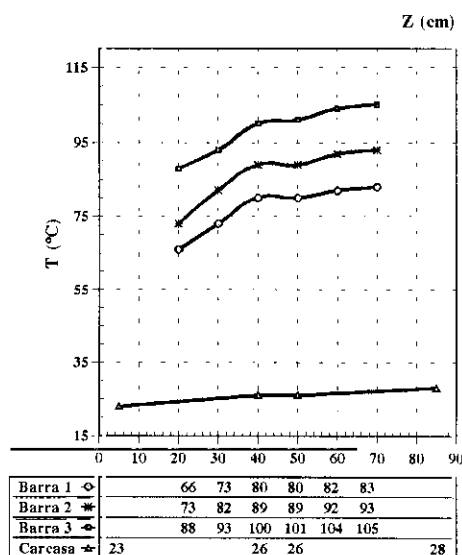

**A.5.5.- Configuración 4 X 4. Rejilla central**  
**SP = 1.62 cm. Carcasa cilíndrica (Dc = 18.7 cm)**  
**Potencia= 5.4 W/barra. Tamb.= 20 °C**

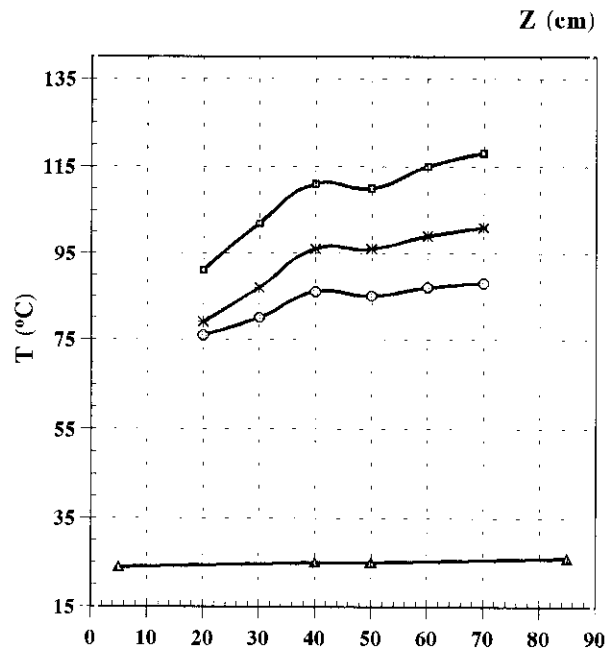

Barra 1 ○	76	80	86	85	87	88
Barra 2 *	79	87	96	96	99	101
Barra 3 □	91	102	111	110	115	118
Carcasa △	24		25	25		26

APÉNDICE A : DATOS EXPERIMENTALES

**A.5.6.- Configuración 4 X 4. Rejilla central**  
 SP = 1.62 cm. Carcasa cilíndrica (Dc = 34.5 cm)  
 Potencia= 1.8 W/barra. Tamb.= 26 °C

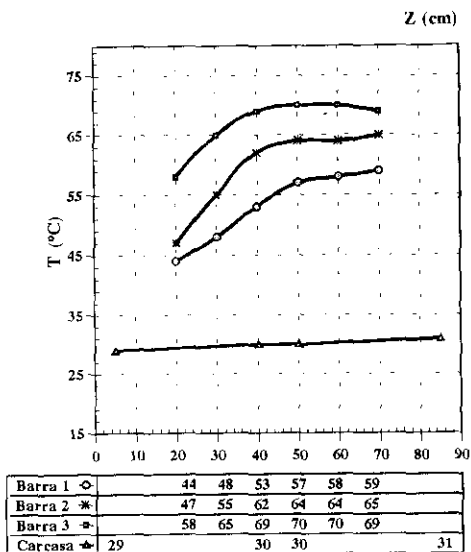

**A.5.7.- Configuración 4 X 4. Rejilla central**  
 SP = 1.62 cm. Carcasa cilíndrica (Dc = 34.5 cm)  
 Potencia= 2.7 W/barra. Tamb.= 27 °C

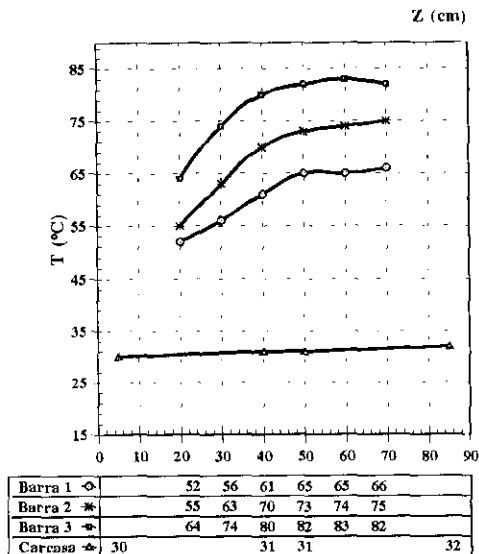

**A.5.8.- Configuración 4 X 4. Rejilla central**  
 SP = 1.62 cm. Carcasa cilíndrica (Dc = 34.5 cm)  
 Potencia= 3.6 W/barra. Tamb.= 29 °C

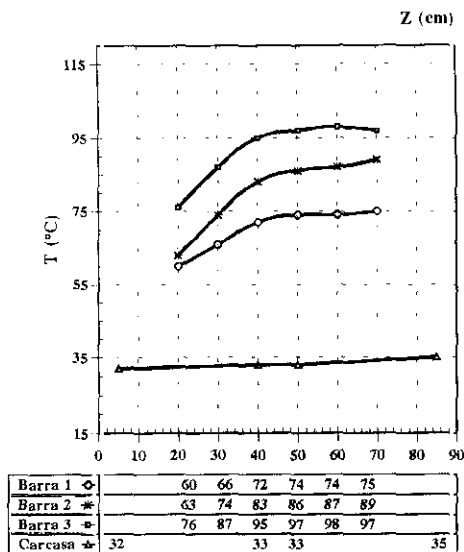

**A.5.9.- Configuración 4 X 4. Rejilla central**  
 SP 1.62 cm. Carcasa cilíndrica (Dc = 34.5 cm)  
 Potencia= 4.5 W/barra. Tamb.= 29 °C

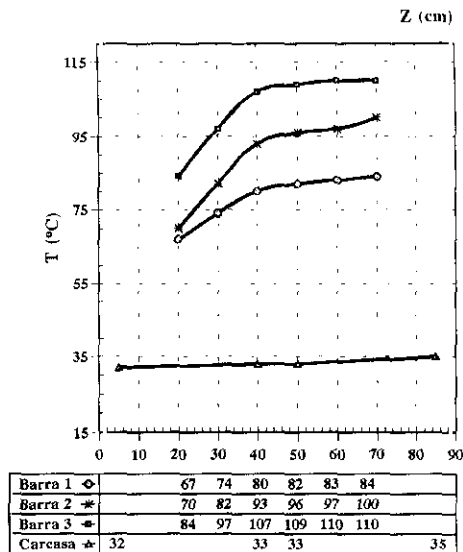

**A.5.10.- Configuración 4 X 4. Rejilla central**  
**SP = 1.62 cm. Carcasa cilíndrica (Dc = 34.5 cm)**  
**Potencia= 5.4 W/barra. Tamb.= 28 °C**

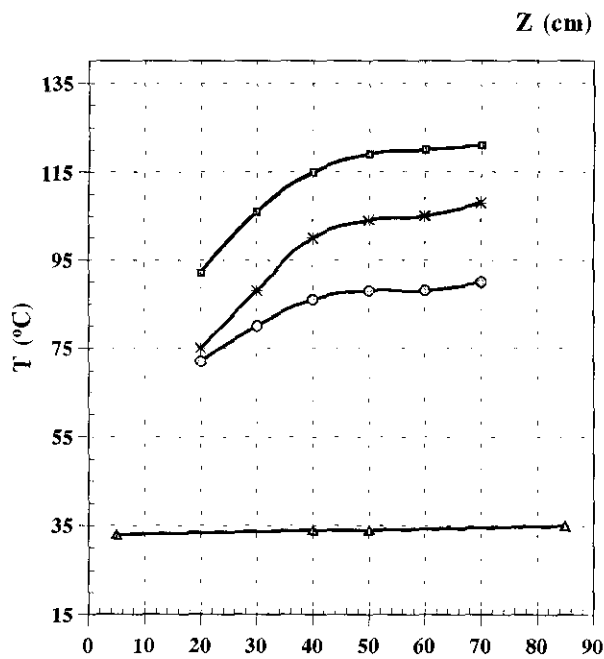

Barra 1 ◯	72	80	86	88	88	90
Barra 2 *	75	88	100	104	105	108
Barra 3 ◻	92	106	115	119	120	121
Carcasa ▲	33		34	34		35

APÉNDICE A : DATOS EXPERIMENTALES

**A.5.11.- Configuración 4 X 4. Rejilla central**  
 SP = 1.62 cm. Carcasa cilíndrica (Dc = 50.9 cm)  
 Potencia= 1.8 W/barra. Tamb.= 23 °C

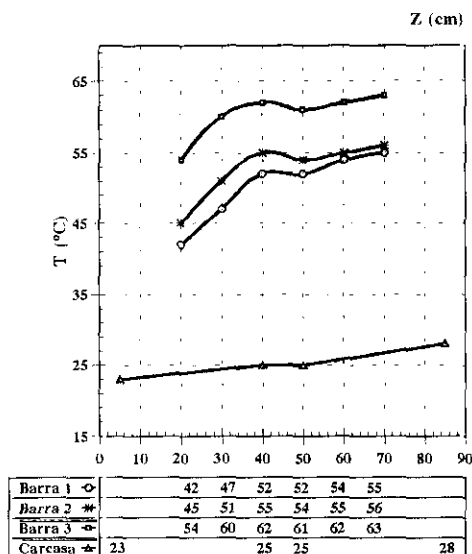

**A.5.12.- Configuración 4 X 4. Rejilla central**  
 SP = 1.62 cm. Carcasa cilíndrica (Dc = 50.9 cm)  
 Potencia= 2.7 W/barra. Tamb.= 22 °C

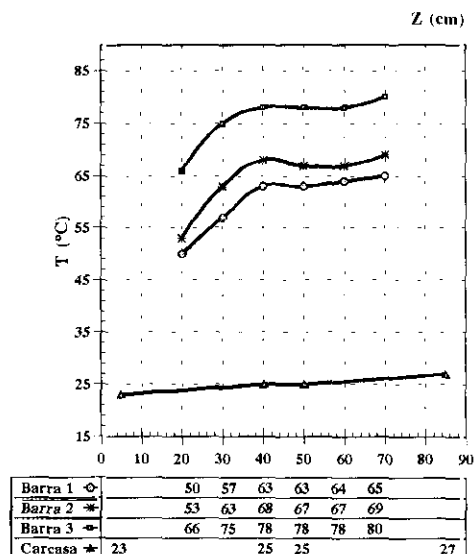

**A.5.13.- Configuración 4 X 4. Rejilla central**  
 SP = 1.62 cm. Carcasa cilíndrica (Dc = 50.9 cm)  
 Potencia= 3.6 W/barra. Tamb.= 24 °C

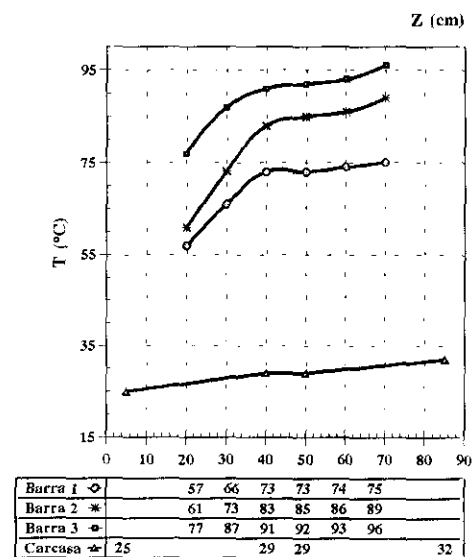

**A.5.14.- Configuración 4 X 4. Rejilla central**  
 SP = 1.62 cm. Carcasa cilíndrica (Dc = 50.9 cm)  
 Potencia= 4.5 W/barra. Tamb.= 21 °C

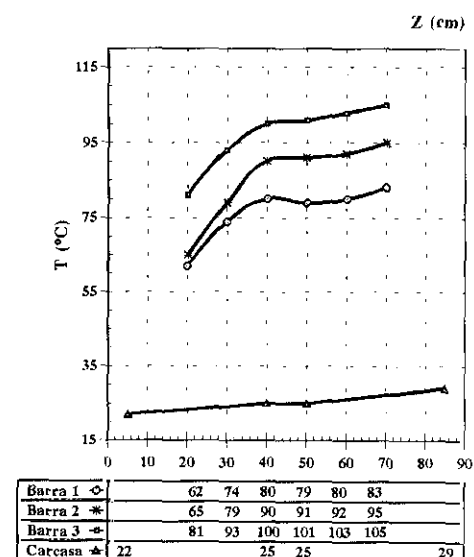

**A.5.15.- Configuración 4 X 4. Rejilla central**  
 SP = 1.62 cm. Carcasa cilíndrica (Dc = 50.9 cm)  
 Potencia= 5.4 W/barra. Tamb.= 21 °C

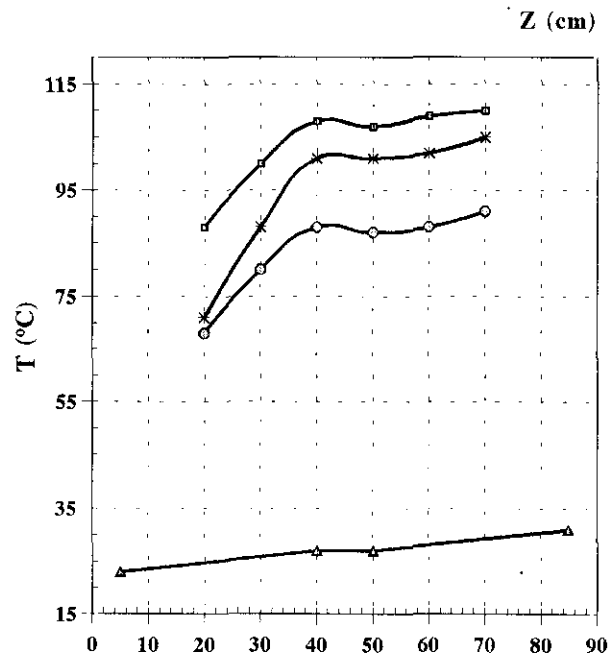

Barra 1 ◯	68	80	88	87	88	91
Barra 2 *	71	88	101	101	102	105
Barra 3 ◻	88	100	108	107	109	110
Carcasa ▲	23		27	27		31

**A.6.- Carcasa cuadrada. Espaciado de 1.62 cm**

**A.6.1.- Configuración 2 X 2. SP = 1.62 cm**  
 Carcasa cuadrada (Lc = 16.4 cm)  
 Potencia = 5.7 W/barra. Tamb. = 22 °C

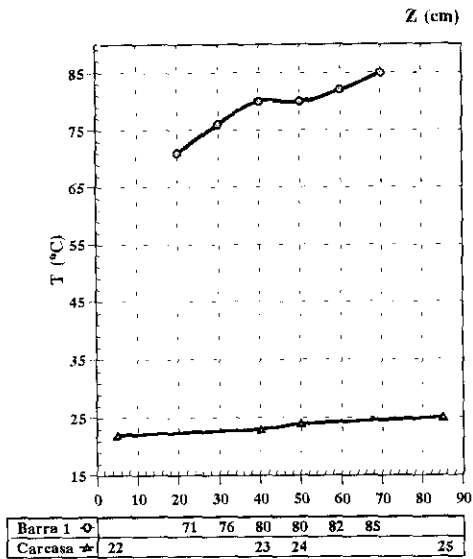

**A.6.2.- Configuración 2 X 2. SP = 1.62 cm**  
 Carcasa cuadrada (Lc = 16.4 cm)  
 Potencia = 6.1 W/barra. Tamb. = 18 °C

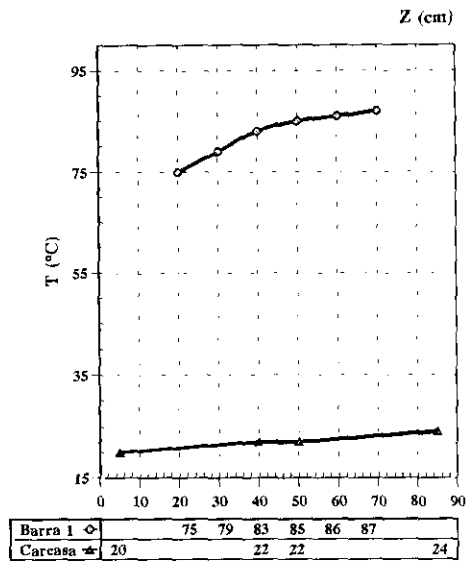

**A.6.3.- Configuración 2 X 2. SP = 1.62 cm**  
 Carcasa cuadrada (Lc = 16.4 cm)  
 Potencia = 7.6 W/barra. Tamb. = 23 °C

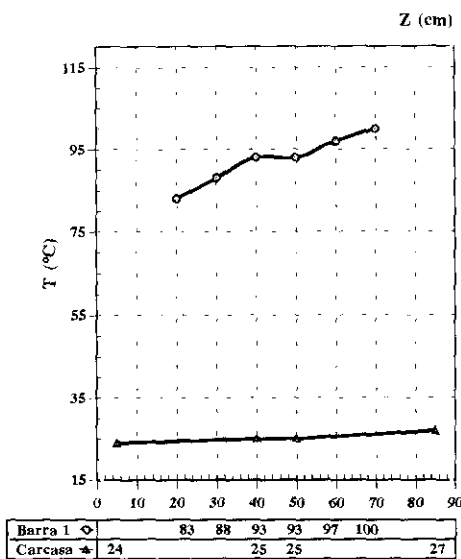

**A.6.4.- Configuración 2 X 2. SP = 1.62 cm**  
 Carcasa cuadrada (Lc = 16.4 cm)  
 Potencia = 11.8 W/barra. Tamb. = 23 °C

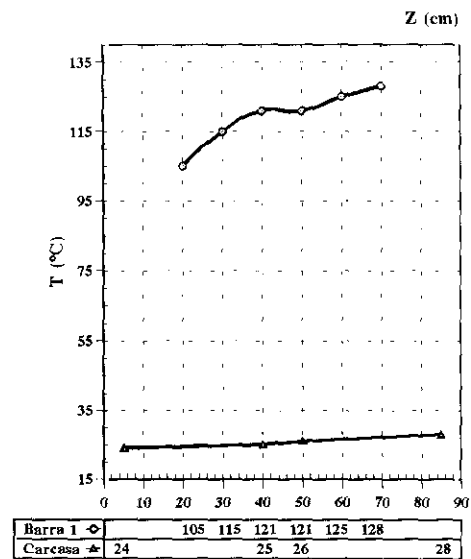



**A.6.5.- Configuración 2 X 2. SP = 1.62 cm**  
**Carcasa cuadrada (Lc = 16.4 cm)**  
**Potencia= 14.5 W/barra. Tamb.= 21 °C**

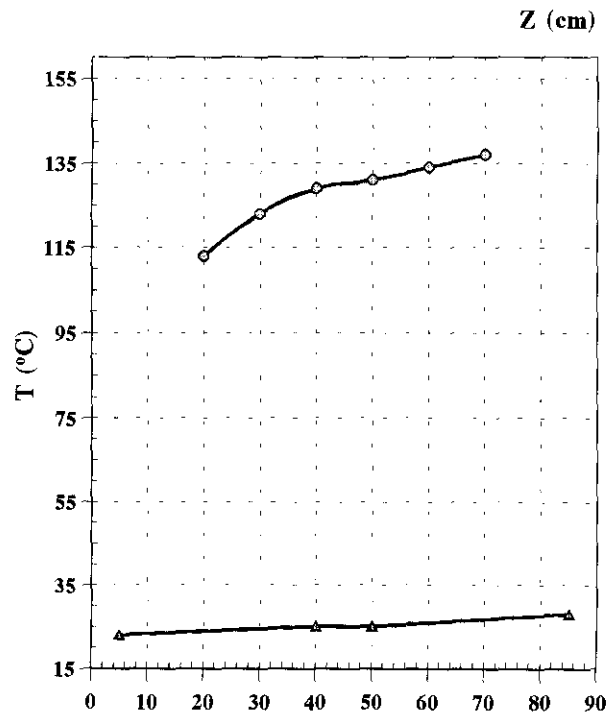

Barra 1 ◊	113	123	129	131	134	137
Carcasa ▲	23		25	25		28

APÉNDICE A : DATOS EXPERIMENTALES

**A.6.6.- Configuración 4 X 4. SP = 1.62 cm**  
**Carcasa cuadrada (Lc = 16.4 cm)**  
**Potencia= 3.4 W/barra. Tamb.= 21 °C**

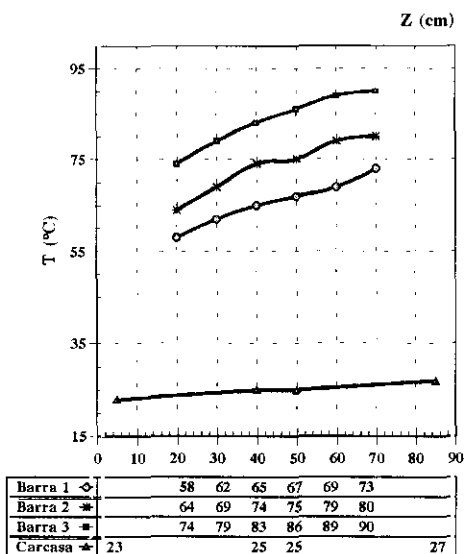

**A.6.7.- Configuración 4 X 4. SP = 1.62 cm**  
**Carcasa cuadrada (Lc = 16.4 cm)**  
**Potencia= 4.3 W/barra. Tamb.= 22 °C**

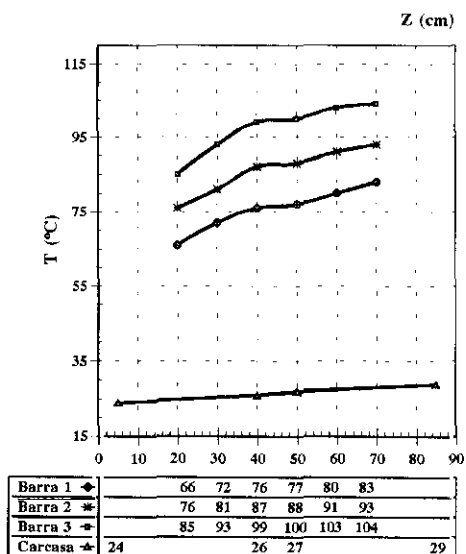

**A.6.8.- Configuración 4 X 4. SP = 1.62 cm**  
**Carcasa cuadrada (Lc = 16.4 cm)**  
**Potencia= 5.8 W/barra. Tamb.= 23 °C**

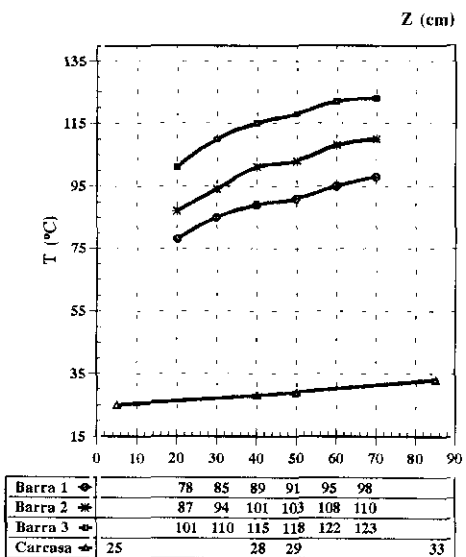

**A.6.9.- Configuración 4 X 4. SP = 1.62 cm**  
**Carcasa cuadrada (Lc = 16.4 cm)**  
**Potencia= 7.4 W/barra. Tamb.= 23 °C**

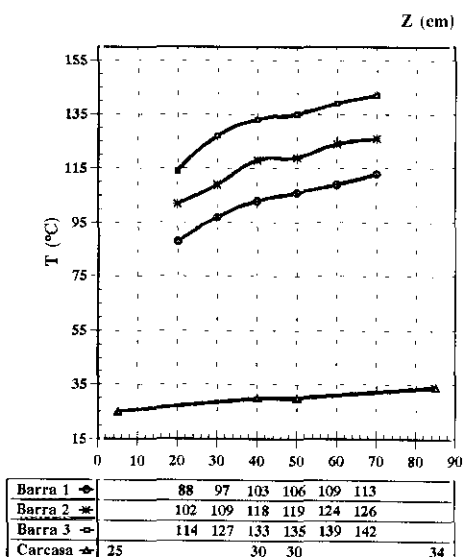

APÉNDICE A : DATOS EXPERIMENTALES

A.6.10.- Configuración 6 x 6. SP = 1.62 cm  
Carcasa cuadrada (Lc = 16.4 cm)  
Potencia = 1.8 W/barra. Tamb.= 20 °C

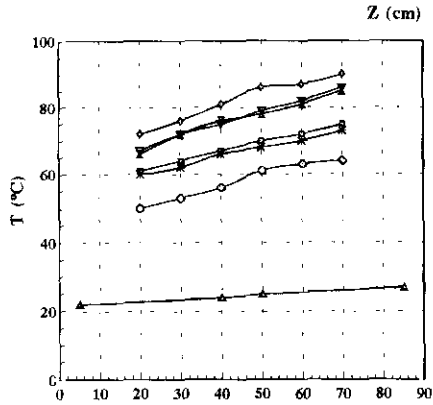

Barra 1 ◊	50	53	56	61	63	64
Barra 2 ✱	60	62	66	68	70	73
Barra 3 ◐	61	64	67	70	72	75
Barra 4 ✱	66	72	76	78	81	85
Barra 5 ✱	67	72	75	79	82	86
Barra 6 ✱	72	76	81	86	87	90
Carcasa ✱	22		24	25		27

A.6.11.- Configuración 6 X 6. SP = 1.62 cm  
Carcasa cuadrada (Lc = 16.4 cm)  
Potencia = 2.0 W/barra. Tamb.= 19 °C

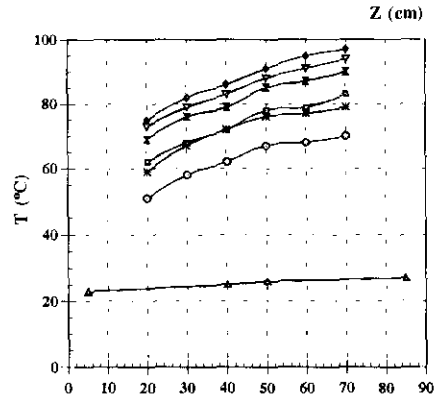

Barra 1 ◊	51	58	62	67	68	70
Barra 2 ✱	59	67	72	76	77	79
Barra 3 ◐	62	68	72	78	79	83
Barra 4 ✱	69	76	79	85	87	90
Barra 5 ✱	73	79	83	88	91	94
Barra 6 ✱	75	82	86	91	95	97
Carcasa ✱	23		25	26		27

A.6.12.- Configuración 6 X 6. SP = 1.62 cm  
Carcasa cuadrada (Lc = 16.4 cm)  
Potencia = 2.6 W/barra. Tamb.= 20 °C

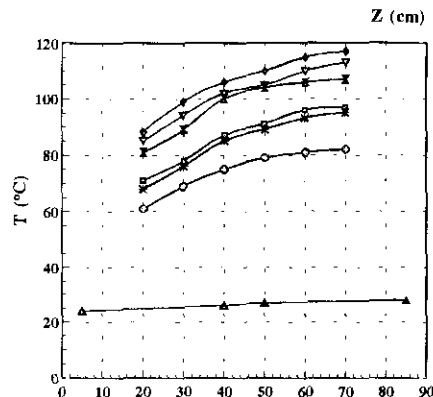

Barra 1 ◊	61	69	75	79	81	82
Barra 2 ✱	68	76	85	89	93	95
Barra 3 ◐	71	78	87	91	96	97
Barra 4 ✱	81	89	100	104	106	107
Barra 5 ✱	85	94	102	105	110	113
Barra 6 ✱	88	99	106	110	115	117
Carcasa ✱	24		26	27		28

A.6.13.- Configuración 6 X 6. SP = 1.62 cm  
Carcasa cuadrada (Lc = 16.4 cm)  
Potencia = 3.4 W/barra. Tamb.= 21 °C

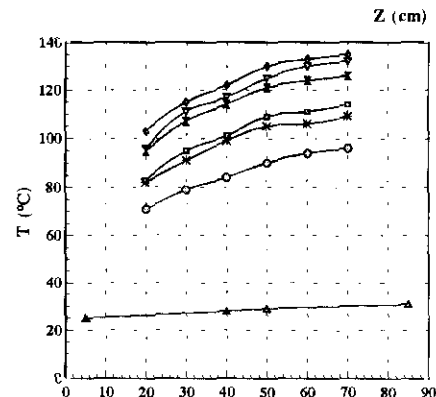

Barra 1 ◊	71	79	84	90	94	96
Barra 2 ✱	82	91	99	105	106	109
Barra 3 ◐	83	95	101	109	111	114
Barra 4 ✱	95	107	114	121	124	126
Barra 5 ✱	96	111	117	125	130	132
Barra 6 ✱	103	115	122	130	133	135
Carcasa ✱	25		28	29		31

**A.7.- Carcasa cuadrada. Rejilla central**

**A.7.1.- Configuración 4 X 4. Rejilla central**  
 SP = 1.62 cm. Carcasa cuadrada (Lc = 16.4 cm)  
 Potencia= 1.8 W/barra. Tamb.= 21 °C

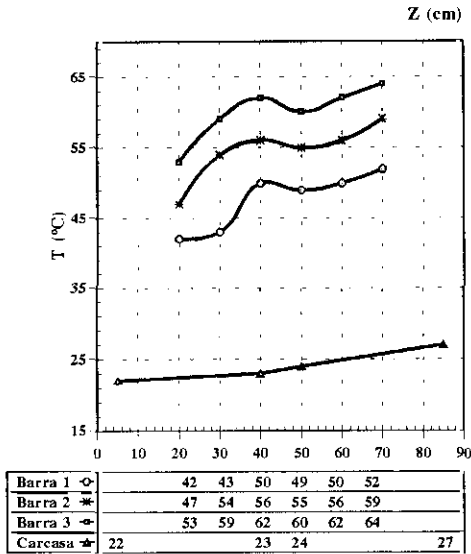

**A.7.2.- Configuración 4 X 4. Rejilla central**  
 SP = 1.62 cm. Carcasa cuadrada (Lc = 16.4 cm)  
 Potencia= 3.3 W/barra. Tamb.= 21 °C

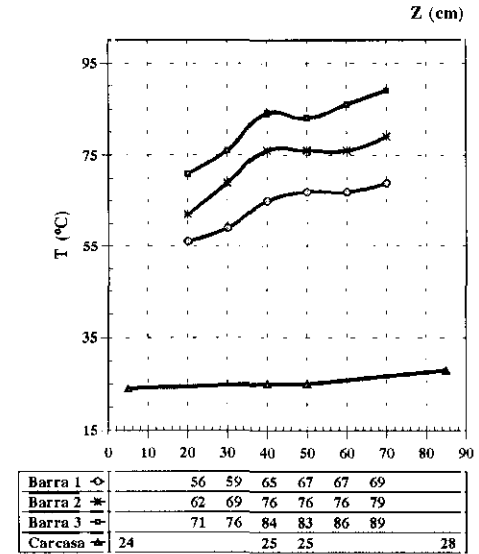

**A.7.3.- Configuración 4 X 4. Rejilla central**  
 SP = 1.62 cm. Carcasa cuadrada (Lc = 16.4 cm)  
 Potencia= 3.8 W/barra. Tamb.= 20 °C

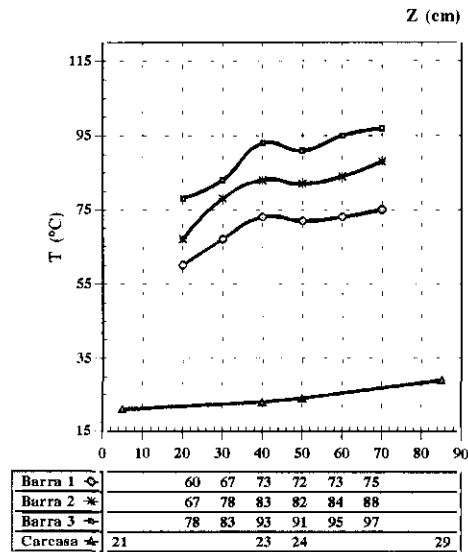

**A.7.4.- Configuración 4 X 4. Rejilla central**  
 SP = 1.62 cm. Carcasa cuadrada (Lc = 16.4 cm)  
 Potencia= 4.3 W/barra. Tamb.= 23 °C

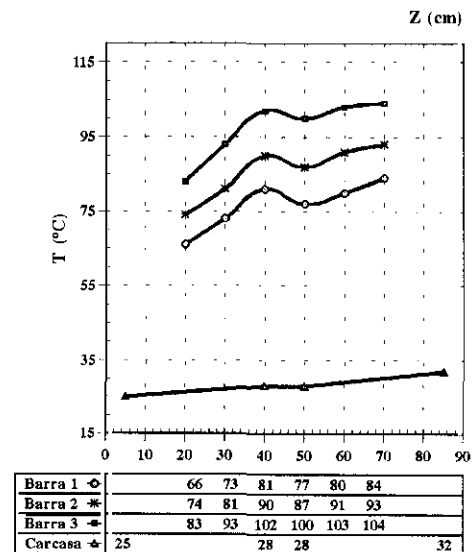

**A.7.5.- Configuración 4 X 4. Rejilla central**  
 SP = 1.62 cm. Carcasa cuadrada (Lc = 16.4 cm)  
 Potencia= 5.8 W/barra. Tamb.= 23 °C

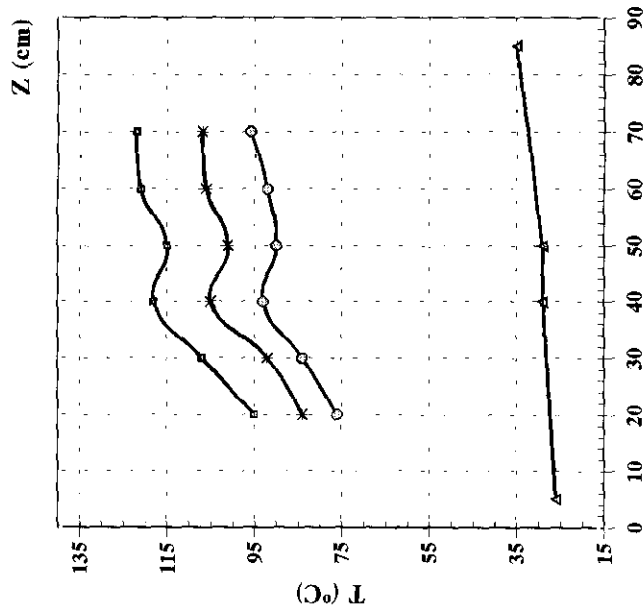

Barra 1 ◊	76	84	93	90	92	96
Barra 2 *	84	92	105	101	106	107
Barra 3 ◻	95	107	118	115	121	122
Carcasa ▲	26	29	29	29	29	35

**A.7.6.- Configuración 4 X 4. Rejilla central**  
 SP = 1.62 cm. Carcasa cuadrada (Lc = 16.4 cm)  
 Potencia= 7.4 W/barra. Tamb.= 24 °C

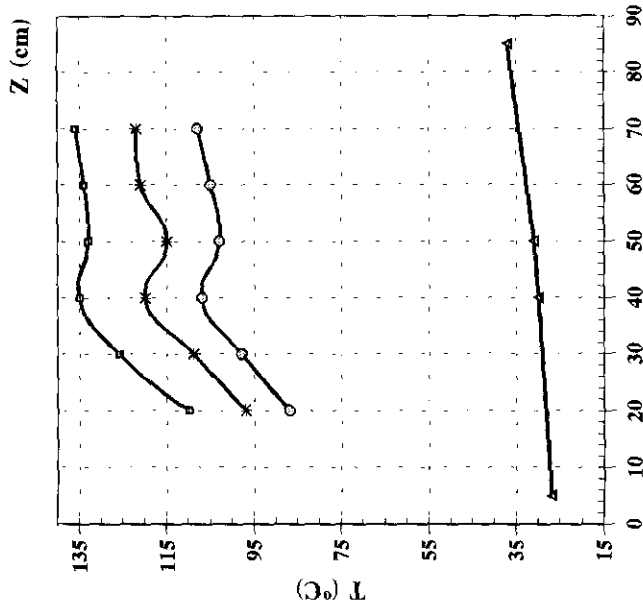

Barra 1 ◊	87	98	107	103	105	108
Barra 2 *	97	109	120	115	121	122
Barra 3 ◻	110	126	135	133	134	136
Carcasa ▲	27	30	31	31	31	37

APÉNDICE A : DATOS EXPERIMENTALES

**A.7.7.- Configuración 6 X 6. Rejilla central**  
 SP = 1.62 cm. Carcasa cuadrada (Lc= 16.4 cm)  
 Potencia = 1.5 W/barra. Tamb.= 19 °C

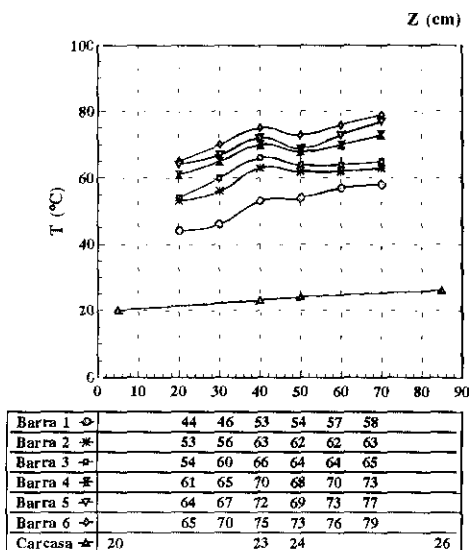

**A.7.8.- Configuración 6 X 6. Rejilla central**  
 SP = 1.62 cm. Carcasa cuadrada (Lc = 16.4 cm)  
 Potencia = 1.8 W/barra. Tamb.= 25 °C

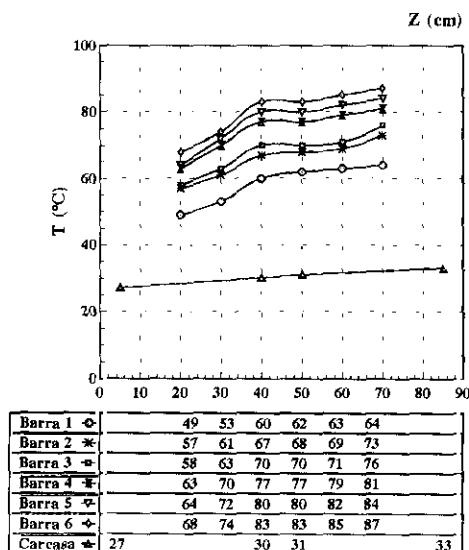

**A.7.9.- Configuración 6 X 6. Rejilla central**  
 SP = 1.62 cm. Carcasa cuadrada (Lc = 16.4 cm)  
 Potencia = 2.0 W/barra. Tamb.= 20 °C

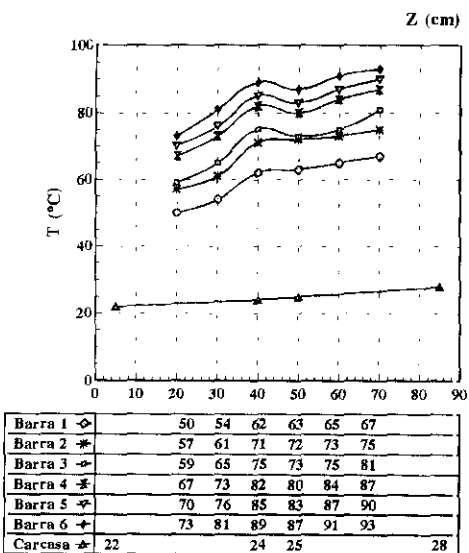

**A.7.10.- Configuración 6 X 6. Rejilla central**  
 SP = 1.62 cm. Carcasa cuadrada (Lc = 16.4 cm)  
 Potencia = 2.1 W/barra. Tamb.= 20 °C

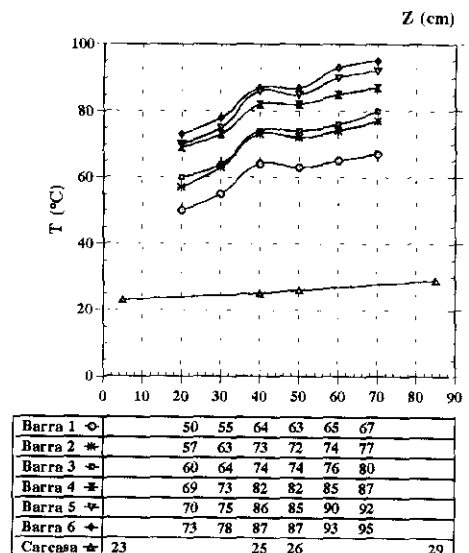

APÉNDICE A : DATOS EXPERIMENTALES

**A.7.11.- Configuración 6 X 6. Rejilla central**  
 SP = 1.62 cm. Carcasa cuadrada (Lc = 16.4 cm)  
 Potencia = 2.6 W/barra. Tamb.= 21 °C

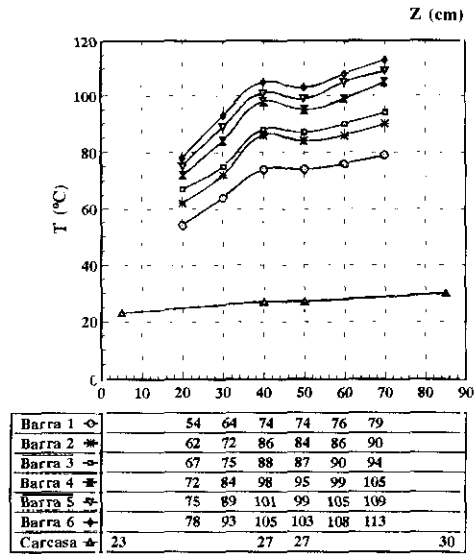

**A.7.12.- Configuración 6 X 6. Rejilla central**  
 SP = 1.62 cm. Carcasa cuadrada (Lc = 16.4 cm)  
 Potencia = 2.7 W/barra. Tamb.= 22 °C

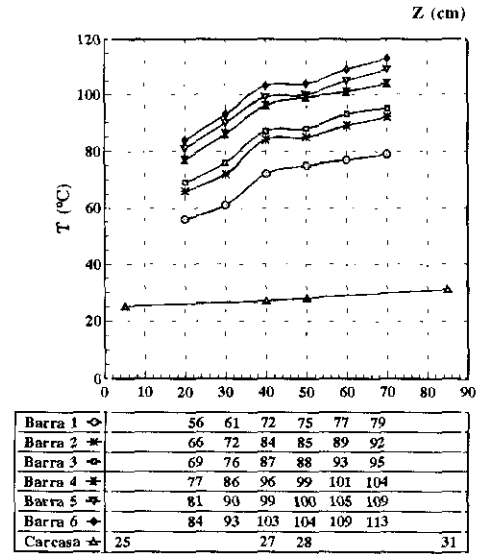

**A.7.13.- Configuración 6 X 6. Rejilla central**  
 SP = 1.62 cm. Carcasa cuadrada (Lc = 16.4 cm)  
 Potencia = 3.4 W/barra. Tamb.= 20 °C

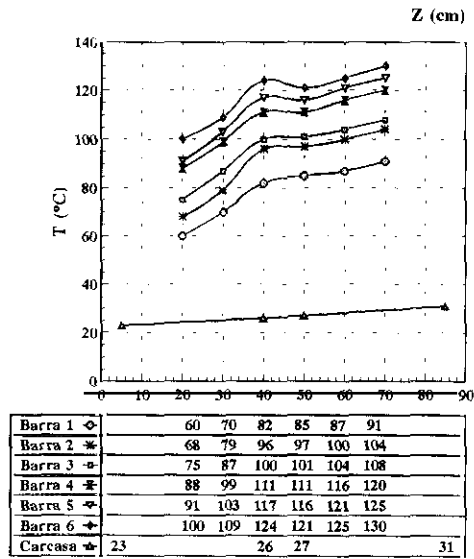

**A.7.14.- Configuración 6 X 6. Rejilla central**  
 SP = 1.62 cm. Carcasa cuadrada (Lc = 16.4 cm)  
 Potencia = 3.5 W/barra. Tamb.= 22 °C

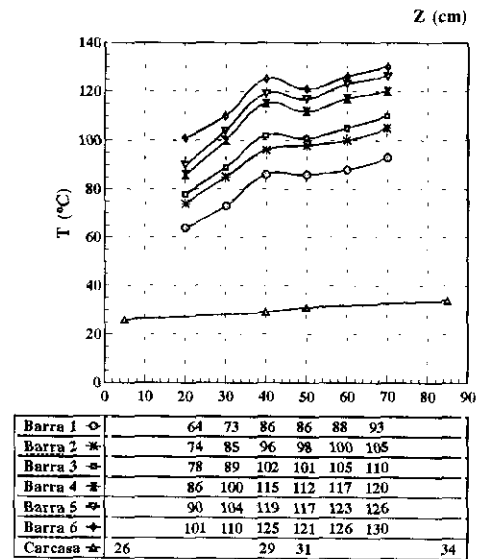

## APÉNDICE B : CÁLCULO DE LOS FACTORES DE VISIÓN

---



### B.1. Ecuaciones base para el cálculo de los factores de visión

#### B.1.1. Factor de visión de un cilindro central con respecto a "N" cilindros

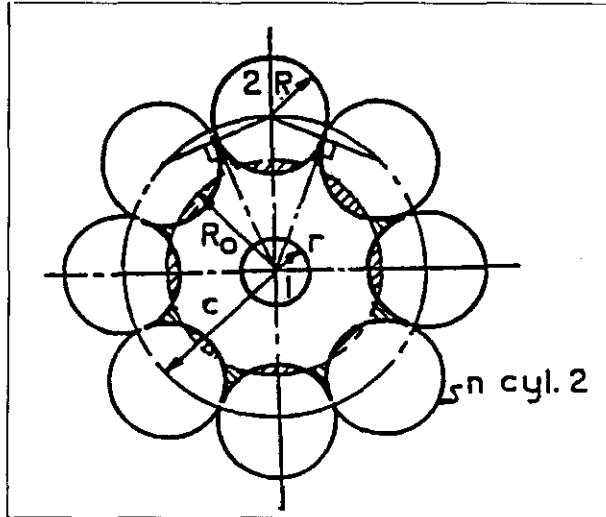

$$F_{12}^N = 1 - \frac{1}{\pi} \left\{ \cos^{-1} \left( \frac{C}{B} \right) - \left( \frac{R^2}{2rL} \right)^2 \left[ \sqrt{\left( C + 2 \left( \frac{R_o}{R} \right)^2 \right)^2 - \left( 2 \cdot \frac{R_o}{R} \left( \frac{r}{R} \right) \right)^2} \right. \right. \\ \left. \left. \cos^{-1} \left( \frac{rC}{R_o B} \right) + C \sin^{-1} \left( \frac{r}{R_o} \right) - \frac{\pi B}{2} \right] \right\} \quad \text{(Ecuación 1)}$$

donde,

$$C = \left( \frac{L}{R} \right)^2 - \left( \frac{R_o}{R} \right)^2 + \left( \frac{r}{R} \right)^2 \\ B = \left( \frac{L}{R} \right)^2 + \left( \frac{R_o}{R} \right)^2 - \left( \frac{r}{R} \right)^2 \\ \frac{R_o}{R} = \sqrt{\frac{2 \cdot \sqrt{(c/R)^2 - 1} - \pi}{2 \cdot \sin^{-1}(R/c)} + 1}$$

**B.1.2. Factores de visión entre cilindros coaxiales de igual longitud**

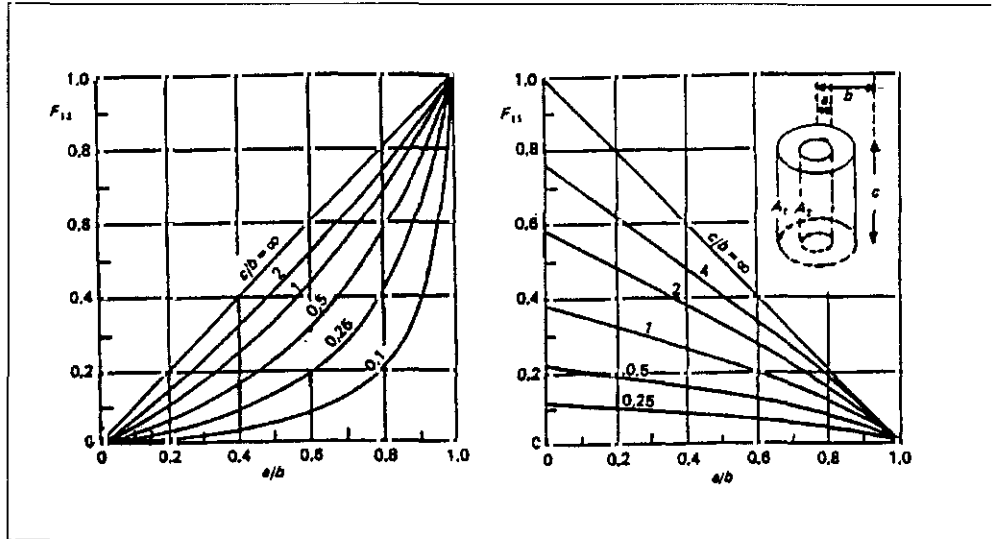

$$\begin{aligned}
 F_{11} = & 1 - \frac{1}{X} + \frac{2}{\pi X} \tan^{-1} \left( \frac{2\sqrt{X^2 - 1}}{Y} \right) \\
 & - \frac{Y}{2\pi X} \left\{ \frac{\sqrt{4X^2 + Y^2}}{Y} \sin^{-1} \left[ \frac{4(X^2 - 1) + (Y^2/X^2)(X^2 - 2)}{Y^2 + 4(X^2 - 1)} \right] \right. \\
 & \left. - \sin^{-1} \left( \frac{X^2 - 2}{X^2} \right) + \frac{\pi}{2} \left( \frac{\sqrt{4X^2 + Y^2}}{Y} - 1 \right) \right\}
 \end{aligned}
 \tag{Ecuación 2}$$

$$F_{12} = \frac{1}{X} - \frac{1}{\pi X} \left\{ \cos^{-1} \frac{B}{A} - \frac{1}{2Y} \left[ \sqrt{(A+2)^2 - (2X)^2} \cos^{-1} \left( \frac{B}{XA} \right) + B \sin^{-1} \left( \frac{1}{X} \right) - \frac{\pi A}{2} \right] \right\}
 \tag{ecuación 3}$$

donde,

$$X = b/a; \quad Y = c/a; \quad A = Y^2 + X^2 - 1; \quad B = Y^2 - X^2 + 1$$

**B.1.3. Factor de visión entre un plano y un cilindro paralelo y centrado**

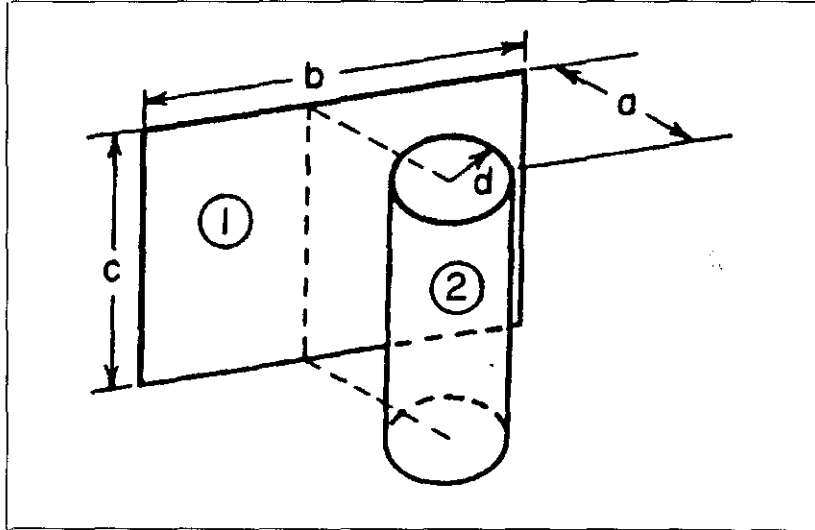

$$F_{1-2} = \frac{2}{Y} \int_0^{Y/2} f(\xi) d\xi$$

(Ecuación 4)

$$f(\xi) = \frac{X}{X^2 + \xi^2} - \frac{X}{\pi(X^2 + \xi^2)} \left\{ \cos^{-1} \left( \frac{B}{A} \right) - \frac{1}{2Z} \left[ \sqrt{A^2 + 4Z^2} \cos^{-1} \left( \frac{B}{A\sqrt{X^2 + \xi^2}} \right) + B \sin^{-1} \left( \frac{1}{\sqrt{X^2 + \xi^2}} \right) - \frac{\pi A}{2} \right] \right\}$$

donde,

$$X = a/d; \quad Y = b/d; \quad Z = c/d$$

$$A = Z^2 + X^2 + \xi^2 - 1; \quad B = Z^2 - X^2 - \xi^2 + 1$$

**B.1.4. Factor de visión entre un plano y un cilindro paralelo y no centrado**

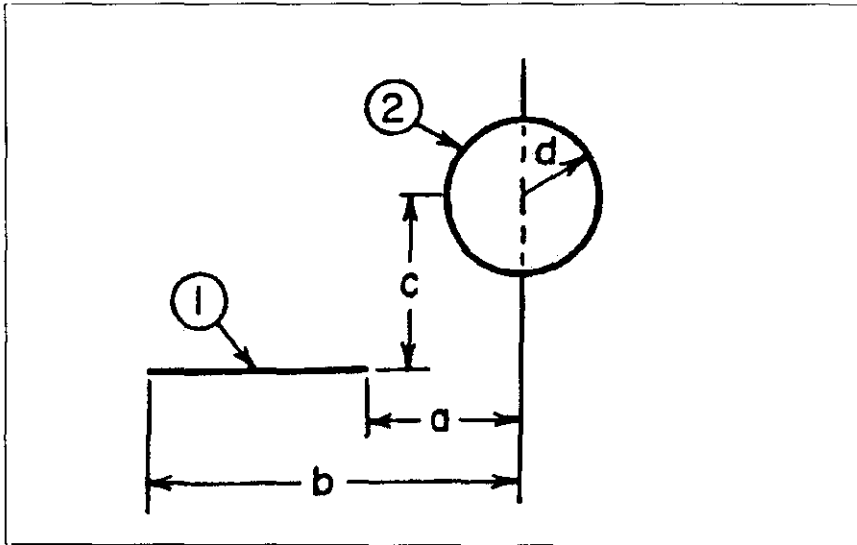

$$F_{1-2} = \frac{1}{Z-Y} \left( \tan^{-1} \frac{Z}{X} - \tan^{-1} \frac{Y}{X} \right) \quad \text{(Ecuación 5)}$$

donde,

$$X = c/d; \quad Y = a/d; \quad Z = b/d$$

**B.1.5. Factor de visión entre dos planos paralelos**

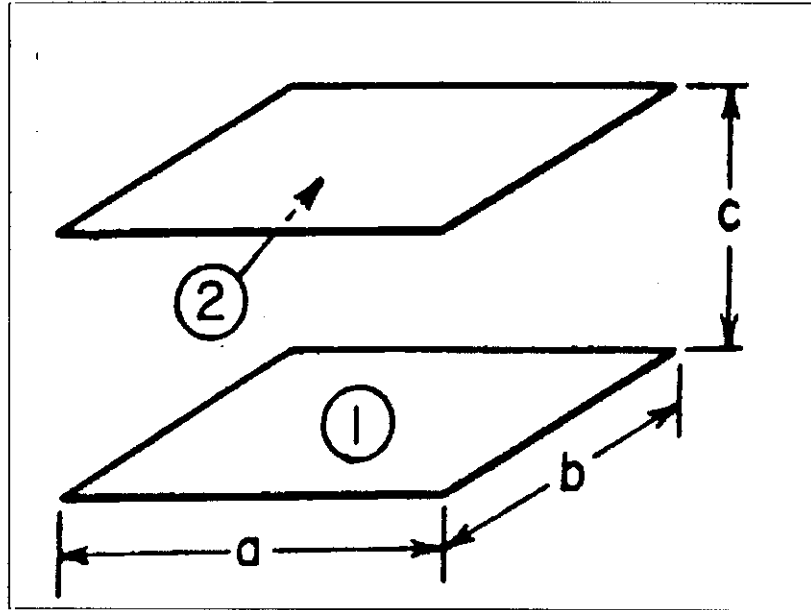

$$F_{1-2}\left(\frac{\pi XY}{2}\right) = \ln\left[\frac{(1+X)(1+Y^2)}{1+X^2+Y^2}\right]^{1/2} + Y\sqrt{1+X^2}\tan^{-1}\left(\frac{Y}{\sqrt{1+X^2}}\right) \\ + X\sqrt{1+Y^2}\tan^{-1}\left(\frac{X}{\sqrt{1+Y^2}}\right) - Y\tan^{-1}Y - X\tan^{-1}X$$

(Ecuación 6)

donde,

$$X = a/c; \quad Y = b/c$$

B.1.6. Factor de visión entre dos planos perpendiculares

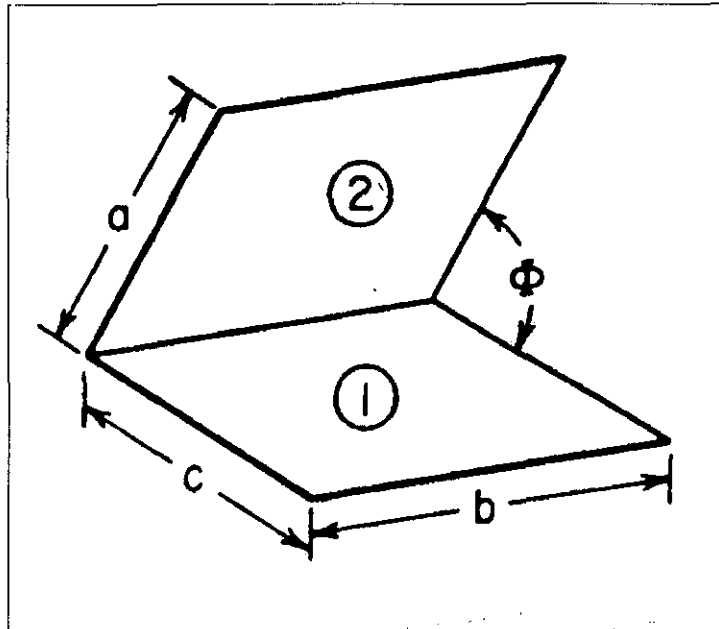

Para  $\Phi = \pi/2$  radianes :

$$F_{1-2}(\pi Y) = \frac{\sin^2 \phi}{4} \left\{ Y^2 \ln \left[ \frac{Y^2(1+Z)}{Z(1+Y^2)} \right] + X^2 \ln \left[ \frac{X^2(1+X^2)^{\cos 2\phi}}{Z(1+Z)^{\cos 2\phi}} \right] \right. \\ \left. + \left( \frac{2}{\sin^2 \phi} - 1 \right) \ln \left[ \frac{(1+X^2)(1+Y^2)}{(1+Z)} \right] \right\} \quad \text{(Ecuación 7)}$$

$$+ Y \tan^{-1} \frac{1}{Y} + X \tan^{-1} \frac{1}{X} - \sqrt{Z} \tan^{-1} \frac{1}{\sqrt{Z}}$$

donde,

$$X = a/b; \quad Y = c/b; \quad Z = X^2 + Y^2$$

**B.2.- Valores de los factores de visión entre elementos del sistema**

**B.2.1. Factores de visión entre barras**

	Distancia entre barras anexas (cm)		
	1.62	2.08	2.60
$F_{1-2}$	0.1245	0.1002	0.0759
$F_{1-3}$	0.1239	0.0891	0.0543
$F_{1-4}$	0.0008	0.0176	0.0344
$F_{1-5}$	---	0.0006	0.0123

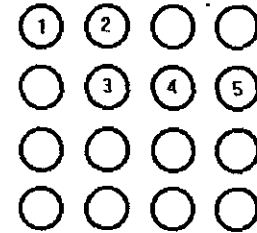

**B.2.2. Factores de visión en carcasa cilíndrica**

B.2.2.1. Barra – carcasa

a) Configuración 1x1

	Diámetro de carcasa (cm)		
	3.5	6.0	10.4
$F_{1-C}$	0.9910	0.9816	0.9668

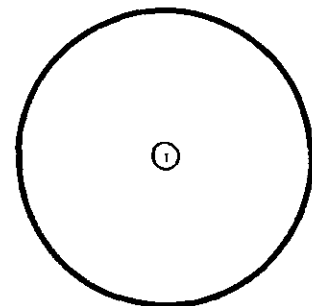

b) Configuración 3x3

	Diámetro carcasa (cm)	Distancia entre barras anexas (cm)		
		1.62	2.08	2.60
$F_{1-C}$	10.4	0.6165	0.6628	0.7066
	17.8	0.6030	0.6455	0.6935
	34.5	0.5948	0.6372	0.6800
$F_{2-C}$	10.4	0.3701	0.4751	0.5820
	17.8	0.3617	0.4657	0.5738
	34.5	0.3472	0.4555	0.5598
$F_{3-C}$	10.4	0.0062	0.2399	0.4735
	17.8	0.0058	0.2357	0.4716
	34.5	0.0042	0.2343	0.4646

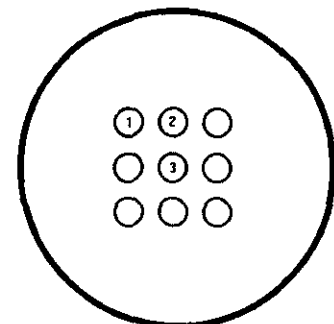

c) Configuración 4x4

	Diámetro de carcasa (cm)	Distancia entre barras anexas (cm)	
		1.62	2.08
F <sub>1-c</sub>	17.8	0.6116	0.6456
	34.5	0.5647	0.5939
	50.9	0.5291	0.5491
F <sub>2-c</sub>	17.8	0.3631	0.4474
	34.5	0.3336	0.4051
	50.9	0.3093	0.3928
F <sub>3-c</sub>	17.8	0.0027	0.1602
	34.5	0.0024	0.1304
	50.9	0.0018	0.1215

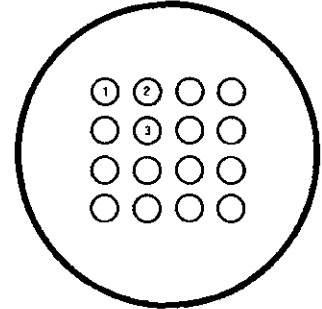

d) Configuración 5x5

	Diámetro de carcasa (cm)	Distancia entre barras anexas (cm)	
		1.62	2.60
F <sub>1-c</sub>	17.8	0.6106	0.6700
	34.5	0.5637	0.6113
	50.9	0.5280	0.5867
F <sub>2-c</sub>	17.8	0.3638	0.4998
	34.5	0.3328	0.4549
	50.9	0.3088	0.4522
F <sub>3-c</sub>	17.8	0.3639	0.4832
	34.5	0.3228	0.4512
	50.9	0.3086	0.4331
F <sub>4-c</sub>	17.8	0.0024	0.2778
	34.5	0.0024	0.2771
	50.9	0.0022	0.2764
F <sub>5-c</sub>	17.8	0.0012	0.2341
	34.5	0.0012	0.2333
	50.9	0.0010	0.2326
F <sub>6-c</sub>	17.8	0.0000	0.1921
	34.5	0.0000	0.1915
	50.9	0.0000	0.1910

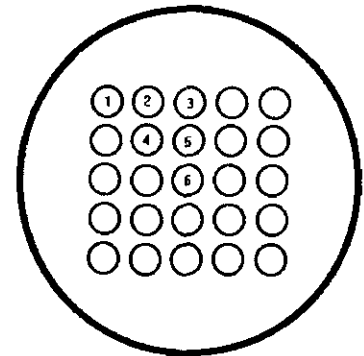



B.2.2.2. Carcasa – barra y carcasa - carcasa

a) Configuración 1x1

	Diámetro de carcasa (cm)		
	3.5	6.0	10.4
$F_{C-1}$	0.3681	0.2127	0.1209
$F_{C-C}$	0.6176	0.7580	0.8264

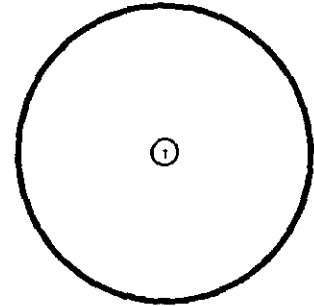

b) Configuración 3x3

	Diámetro carcasa (cm)	Distancia entre barras anexas (cm)		
		1.62	2.08	2.60
$F_{C-1}$	10.4	0.0771	0.0829	0.0883
	17.8	0.0440	0.0471	0.0506
	34.5	0.0224	0.0240	0.0256
$F_{C-2}$	10.4	0.0463	0.0594	0.0728
	17.8	0.0264	0.0340	0.0419
	34.5	0.0131	0.0172	0.0211
$F_{C-3}$	10.4	0.0008	0.0300	0.0592
	17.8	0.0004	0.0172	0.0344
	34.5	0.0002	0.0088	0.0175
$F_{C-C}$	10.4	0.4519	0.3343	0.2148
	17.8	0.6166	0.5429	0.4745
	34.5	0.6680	0.5751	0.5338

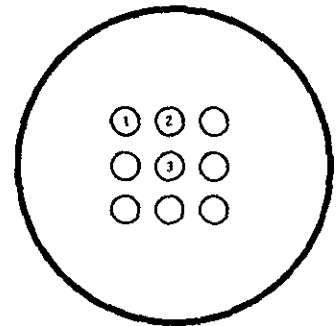

c) Configuración 4x4

	Diámetro de carcasa (cm)	Distancia entre barras anexas (cm)	
		1.62	2.08
$F_{C-1}$	17.8	0.0447	0.0472
	34.5	0.0213	0.0224
	50.9	0.0135	0.0140
$F_{C-2}$	17.8	0.0265	0.0327
	34.5	0.0126	0.0153
	50.9	0.0079	0.0100
$F_{C-3}$	17.8	0.0002	0.0264
	34.5	0.0001	0.0049
	50.9	0.0000	0.0031
$F_{C-C}$	17.8	0.5278	0.3335
	34.5	0.6262	0.5384
	50.9	0.6541	0.5784

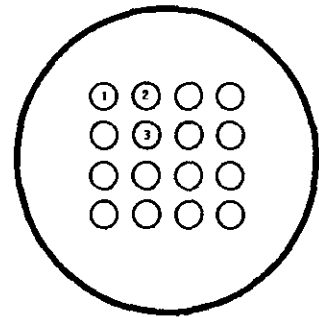

d) Configuración 5x5

	Diámetro de carcasa (cm)	Distancia entre barras anexas (cm)	
		1.62	2.60
$F_{C-1}$	17.8	0.0446	0.0489
	34.5	0.0212	0.0230
	50.9	0.0135	0.0150
$F_{C-2}$	17.8	0.0266	0.0365
	34.5	0.0125	0.0171
	50.9	0.0079	0.0115
$F_{C-3}$	17.8	0.0266	0.0353
	34.5	0.0125	0.0170
	50.9	0.0079	0.0111
$F_{C-4}$	17.8	0.0002	0.0203
	34.5	0.0001	0.0104
	50.9	0.0001	0.0071
$F_{C-5}$	17.8	0.0001	0.0171
	34.5	0.0000	0.0088
	50.9	0.0000	0.0059
$F_{C-6}$	17.8	0.0000	0.0140
	34.5	0.0000	0.0072
	50.9	0.0000	0.0049
$F_{C-C}$	17.8	0.4301	0.1563
	34.5	0.5915	0.4499
	50.9	0.6307	0.5574

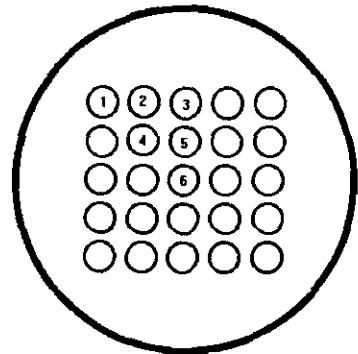

B.2.2.3. Barra – base y carcasa – base

a) Configuración 1x1

	Diámetro de carcasa (cm)		
	3.5	6.0	10.4
$F_{1-B}$	0.0090	0.0184	0.0332
$F_{C-B}$	0.0143	0.0293	0.0527

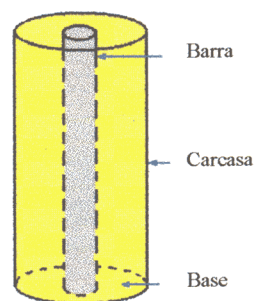

b) Configuración. 3x3

	Diámetro carcasa (cm)	Distancia entre barras anexas (cm)		
		1.62	2.08	2.60
$F_{1-B}$	10.4	0.0090	0.0125	0.0185
	17.8	0.0225	0.0298	0.0316
	34.5	0.0307	0.0381	0.0451
$F_{2-B}$	10.4	0.0070	0.0109	0.0129
	17.8	0.0154	0.0203	0.0211
	34.5	0.0299	0.0305	0.0351
$F_{3-B}$	10.4	0.0002	0.0029	0.0057
	17.8	0.0006	0.0071	0.0076
	34.5	0.0022	0.0085	0.0146
$F_{C-B}$	10.4	0.0537	0.0665	0.0816
	17.8	0.1014	0.1155	0.1211
	34.5	0.1898	0.2513	0.2619

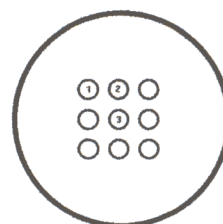
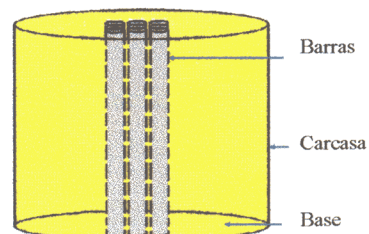

c) Configuración 4x4

	Diámetro de carcasa (cm)	Distancia entre barras anexas (cm)	
		1.62	2.08
<b>F<sub>1-B</sub></b>	17.8	0.0139	0.0285
	34.5	0.0608	0.0802
	50.9	0.0964	0.1250
<b>F<sub>2-B</sub></b>	17.8	0.0132	0.0292
	34.5	0.0427	0.0615
	50.9	0.0670	0.0738
<b>F<sub>3-B</sub></b>	17.8	0.0005	0.0122
	34.5	0.0008	0.0420
	50.9	0.0014	0.0509
<b>F<sub>C-B</sub></b>	17.8	0.0806	0.1105
	34.5	0.1874	0.2300
	50.9	0.2287	0.2732

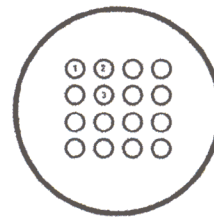
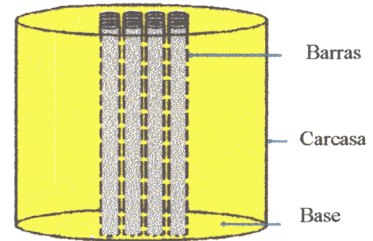

d) Configuración. 5x5

	Diámetro de carcasa (cm)	Distancia entre barras anexas (cm)	
		1.62	2.60
<b>F<sub>1-B</sub></b>	17.8	0.0149	0.0305
	34.5	0.0618	0.0892
	50.9	0.0975	0.1138
<b>F<sub>2-B</sub></b>	17.8	0.0125	0.0238
	34.5	0.0435	0.0687
	50.9	0.0675	0.0714
<b>F<sub>3-B</sub></b>	17.8	0.0116	0.0183
	34.5	0.0427	0.0503
	50.9	0.0669	0.0684
<b>F<sub>4-B</sub></b>	17.8	0.0008	0.0146
	34.5	0.0008	0.0153
	50.9	0.0010	0.0160
<b>F<sub>5-B</sub></b>	17.8	0.0004	0.0141
	34.5	0.0004	0.0149
	50.9	0.0006	0.0156
<b>F<sub>6-B</sub></b>	17.8	0.0000	0.0119
	34.5	0.0000	0.0125
	50.9	0.0000	0.0130
<b>F<sub>C-B</sub></b>	17.8	0.0711	0.0513
	34.5	0.1733	0.1693
	50.9	0.2201	0.1893

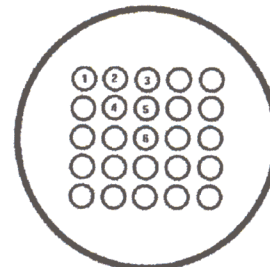
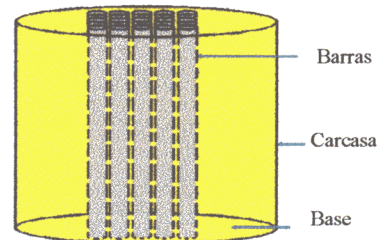

**B.2.3. Factores de visión en carcasa cuadrada**

B.2.3.1. Barra – carcasa

	Conf. 6x6	Conf. 4x4	Conf. 2x2
$F_{1-C}$	0.6163	0.6110	0.6070
$F_{2-C}$	0.3718	0.3683	
$F_{3-C}$	0.3716	0.0025	
$F_{4-C}$	0.0024		
$F_{5-C}$	0.0012		
$F_{6-C}$	0.0000		

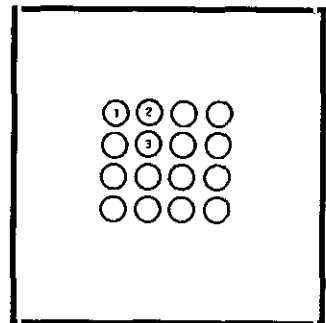
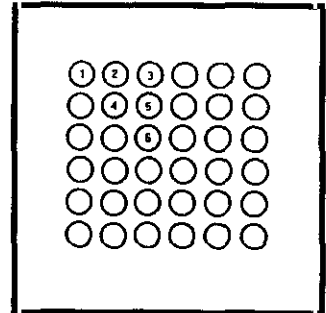

B.2.3.2. Carcasa – barra y carcasa - carcasa

	Conf. 6x6	Conf. 4x4	Conf. 2x2
$F_{C-C}$	0.4054	0.5819	0.7435
$F_{C-1}$	0.0384	0.0380	0.0378
$F_{C-2}$	0.0232	0.0229	
$F_{C-3}$	0.0231	0.0001	
$F_{C-4}$	0.0002		
$F_{C-5}$	0.0001		
$F_{C-6}$	0.0000		

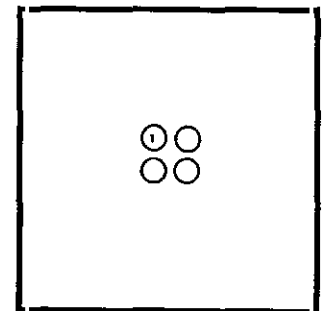

B.2.3.3. Barra - base y carcasa - base

	Conf. 6x6	Conf. 4x4	Conf. 2x2
$F_{C-B}$	0.0690	0.0825	0.1053
$F_{1-B}$	0.0092	0.0145	0.0201
$F_{2-B}$	0.0045	0.0080	
$F_{3-B}$	0.0039	0.0007	
$F_{4-B}$	0.0008		
$F_{5-B}$	0.0004		
$F_{6-B}$	0.0000		

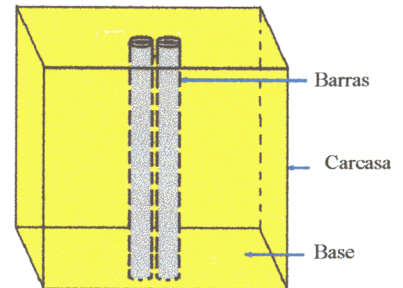
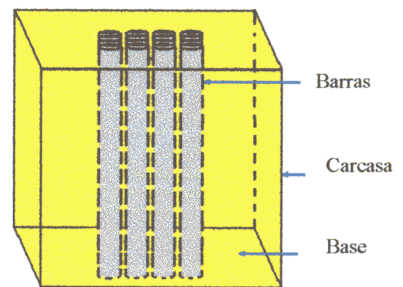
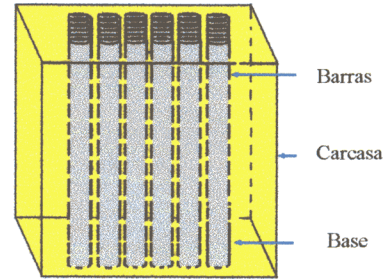

## APÉNDICE C : LISTADO DE PROGRAMA DE CÁLCULO

---

## C. - Listado de programa de cálculo

```

10 REM progma 3x3-CYL - 10.4
20 REM espaciado 2.0
30 '
40 CLS
50 REM Se ajustan N series de valores de y, x1, x2, ... xk a una ecuación del tipo
    y = a1*x1+a2*x2+...+ak*xk
    60 PRINT " Se ajustan N series de valores de y, x1, x2, ... xk a una ecuación del tipo":PRINT:PRINT "
    y = a0+a1*x1+a2*x2+...+ak*xk"
70 PRINT:PRINT:PRINT
80 INPUT "VELOCIDAD. ENTRE 1 Y 10 "; VEL
90 FOR WC=1 TO 10000/VEL : NEXT WC
100 PRINT:PRINT
110 '
120 PRINT "*****"
130 INPUT "Longitud del elemento (cm)";LON
140 INPUT "Número de barras en la diagonal";NB
150 INPUT "Diámetro de carcasa (cm)";DC
160 INPUT "número de variables independientes (o grado del polinomio), k";K
170 INPUT "número de series de datos, N"; N
180 DIM N(N,2*K)
190 DIM P(K+1,K+1)
200 DIM X(K+1)
210 DIM B(K+2)
220 DIM T(K+2)
230 DIM ZK(K-1)
240 DIM H(K-1)
250 DIM RA(K+1)
260 DIM NU(K-1)
270 DIM QC(K-1)
280 DIM LRA(K+1)
290 DIM LNU(K-1)
300 DIM BETA(K)
310 DIM ALPHA(K)
320 DIM VISC(K)
330 DIM COND(K)

```



```

340 DIM Q(K+1, K+1)
350 DIM R(K+1)
360 FOR I=1 TO N
370 FOR J=1 TO K+1
380 READ P(I,J)
390 NEXT J
400 NEXT I
410 OPEN "A",#1,"310420.OUT"
420 PRINT #1,"  "
430 PRINT #1,"CARC. CYL. Dc=10.4. Configuración.3x3. Sin rejilla central. SP = 2.0"
440 PRINT #1,"===== "
450 PRINT #1,"  "
460 RESTORE 1660
470 FOR M=1 TO K+2
480 READ B(M)
490 T(M)=B(M)
500 B(M)= (5.67*10^-8)*((B(M)+273)^4)
510 NEXT M
520 PEL= T(6)*(3.14*0.013*LON/100)
530 PT=PEL*(NB)^2
540 PRINT #1,"POWER(W/m2)=";T(6),"Q supplied (W)=";PT
550 PRINT #1,"  "
560 GOSUB 960
570 I1=0:J1=1:J=1
580 FOR I=J TO K+1
590 SUM=0
600 FOR U=1 TO J-1
610 SUM=SUM+Q(I,U)*Q(U,J)
620 NEXT U
630 Q(I,J)=P(I,J)-SUM
640 NEXT I
650 I1=I1+1
660 IF I>K+1 AND J>K+1 THEN GOTO 840
670 LET I=I1
680 FOR J=I+1 TO K+1
690 SUM=0
700 FOR S= 1 TO I-1
710 SUM=SUM+Q(I,S)*Q(S,J)
720 NEXT S
730 Q(I,J)=1/Q(I,I)*(P(I,J)-SUM)
740 NEXT J
750 SUM=0

```

```

760 IF I=1 THEN GOTO 800
770 FOR F=1 TO I-1
780 SUM=SUM+Q(I,F)*R(F)
790 NEXT F
800 R(I)=1/Q(I,I)*(B(I)-SUM)
810 J1=J1+1
820 J=J1
830 GOTO 580
840 '
850 FOR I=K+1 TO 1 STEP -1
860 SUM=0
870 IF I=K+1 THEN GOTO 910
880 FOR E=I+1 TO K+1
890 SUM=SUM+Q(I,E)*X(E)
900 NEXT E
910 X(I)=R(I)-SUM
920 NEXT I
930 GOSUB 1260
940 '
950 '
960 ' DATOS EN PANTALLA
970 ' MATRIZ DE FACTORES DE VISIÓN
980 PRINT
990 PRINT " MATRIZ DE FACTORES DE VISIÓN"
1000 FOR I=1 TO K+1
1010 FOR J=1 TO K+1
1020 PRINT " P(";I;";";J;")= ";P(I,J)
1030 NEXT J
1040 NEXT I:PRINT "      "
1050 PRINT:PRINT:PRINT
1060 FOR WC=1 TO 10000/VEL :NEXT WC
1070 PRINT #1,"TEMPER.      RAYLEIGH NUMBER"
1080 BETA=1/(273+T(5))
1090 FOR I=1 TO K
1100 ALPHA(I)=(1.85+(.0155*(T(I)+T(5))/2))*1E-5
1110 VISC(I)=(1.298+(.0111*(T(I)+T(5))/2))*1E-5
1120 COND(I)=.0239+(.000066*(T(I)+T(5))/2)
1130 NEXT I
1140 FOR M=1 TO K-1
1150 RA(M)= 9.81*BETA*(.013^3)*(T(M)-T(5))/(ALPHA(I)*VISC(I))
1160 LRA(M)=LOG(RA(M))
1170 PRINT #1,"T(";M;")=";T(M)," ""RAL(";M;")=";RA(M)," ""L.RAL(";M;")=";LRA(M)

```

```

1180 NEXT M:PRINT #1,"      "
1190 PRINT #1,"T ENV.(°C)=";T(4)
1200 PRINT #1,"T WALL (°C)=";T(5)
1210 PRINT #1,"      "
1220 FOR WC=1 TO 10000/VEL :NEXT WC
1230 CLS
1240 RETURN
1250 '
1260 ' PRESENTACIÓN DE RESULTADOS
1270 PRINT #1," ====="
1280 PRINT:PRINT:PRINT "resultados...":PRINT:PRINT
1290 PRINT #1,"RADIOS.(W/m2)      RADIAT. HEAT (W/m2)      CONV. HEAT (W/m2)"
1300 FOR I=1 TO K-1
1310 ZK(I)=.73/.27*(B(I)-X(I))
1320 IF (I=1 OR I=2 OR I=3) THEN QC(I)=T(6)-ZK(I)
1330 H(I)=QC(I)/(T(I)-T(5))
1340 PRINT #1,"RADIO(";I;")=";X(I),""QR(";I;")=";ZK(I),""QC(";I;")=";QC(I)
1350 NEXT I:PRINT #1,"      "
1360 PRINT #1,"CONV.COEF.(W/m2°C)  NUSSELT NUMBER"
1370 FOR L=1 TO K-1
1380 NU(L)=.013*H(L)/COND(L): IF NU(L)>0 THEN LNU(L)= LOG(NU(L))
1390 PRINT #1,"H(";L;")=";H(L),""NUS(";L;")=";NU(L),""L.NUS(";L;")=";LNU(L)
1400 NEXT L
1410 PRINT #1,"      "
1420 PRINT #1,"BUNDLE"
1430 DHAZ=.013*NB
1440 ANN=(DC/100)-DHAZ
1450 RAG=9.81*BETA*((ANN)^3)*(T(3)-T(5))/(ALPHA(4)*VISC(4))
1460 LLAG=LOG(RAG)
1470 SUP=3.14*.013*LON/100
1480 QCTOT=(QC(3)+4*QC(2)+4*QC(1))*SUP
1490 UGL=QCTOT/((T(3)-T(5))*3.14*DHAZ*LON/100)
1500 PCTGR=(PT-QCTOT)/PT*100
1510 NUG=UGL*ANN/COND(4)
1520 LNUG=LOG(NUG)
1530 PRINT #1,"GLOBAL COEF.=";UGL
1540 PRINT #1,"RAYL(G)=";RAG, ""L.RAYL(G)=";LLAG
1550 PRINT #1,"NUS(G)=";NUG, ""L.NUS(G)=";LNUG
1560 PRINT #1,"% RADIAT.=";PCTGR
1570 PRINT #1,"      "
1580 CLOSE #1
1590 GOTO 2100

```

APÉNDICE C : LISTADO DE PROGRAMA DE CÁLCULO

---

1600 DATA 1.3699,-0.0816,-0.0201,-0.0068,-0.2614  
1610 DATA -0.0816,1.3297,-0.0281,-0.0048,-0.2152  
1620 DATA -0.0803,-0.1123,1.3699,-0.0061,-0.1752  
1630 DATA 0.0,0.0,0.0,1.0,0.0  
1640 DATA -0.0266,-0.0219,-0.0045,-0.0061,1.0591  
1650 REM CARCASA CILÍNDRICA. DC=10.4 CM. SIN REJILLA. SP =2.0 CM  
1660 DATA 38,39,39,22,28,73  
1670 DATA 53,55,57,28,39,155  
1680 DATA 68,69,71,28,43,234  
1690 DATA 96,99,103,28,54,490  
1700 STOP  
1710 END

## APÉNDICE D : PROPIEDADES TERMOFÍSICAS DEL AIRE

---

**D. - Propiedades termofísicas del aire**

**D.1. - Viscosidad cinemática**

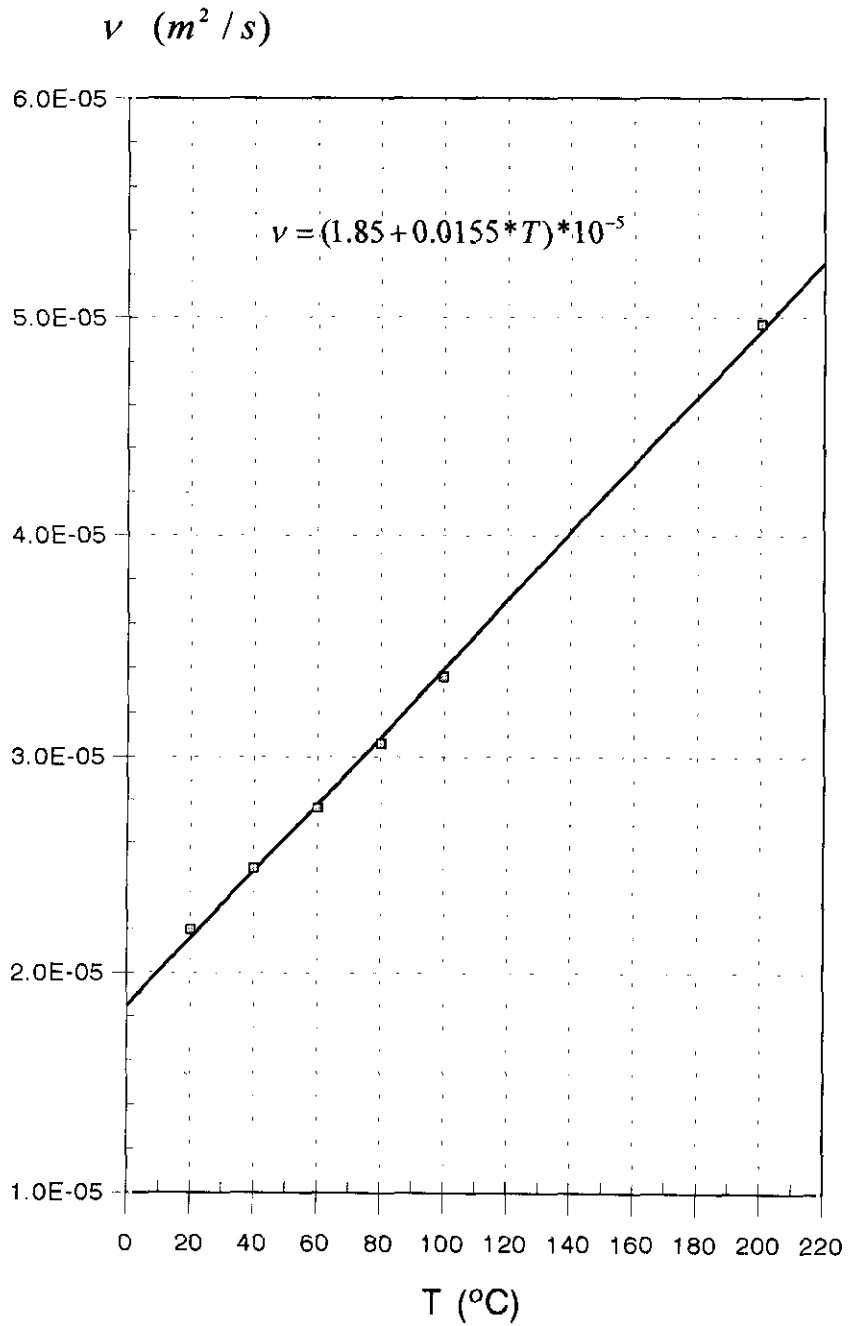

D.2. – Difusividad térmica

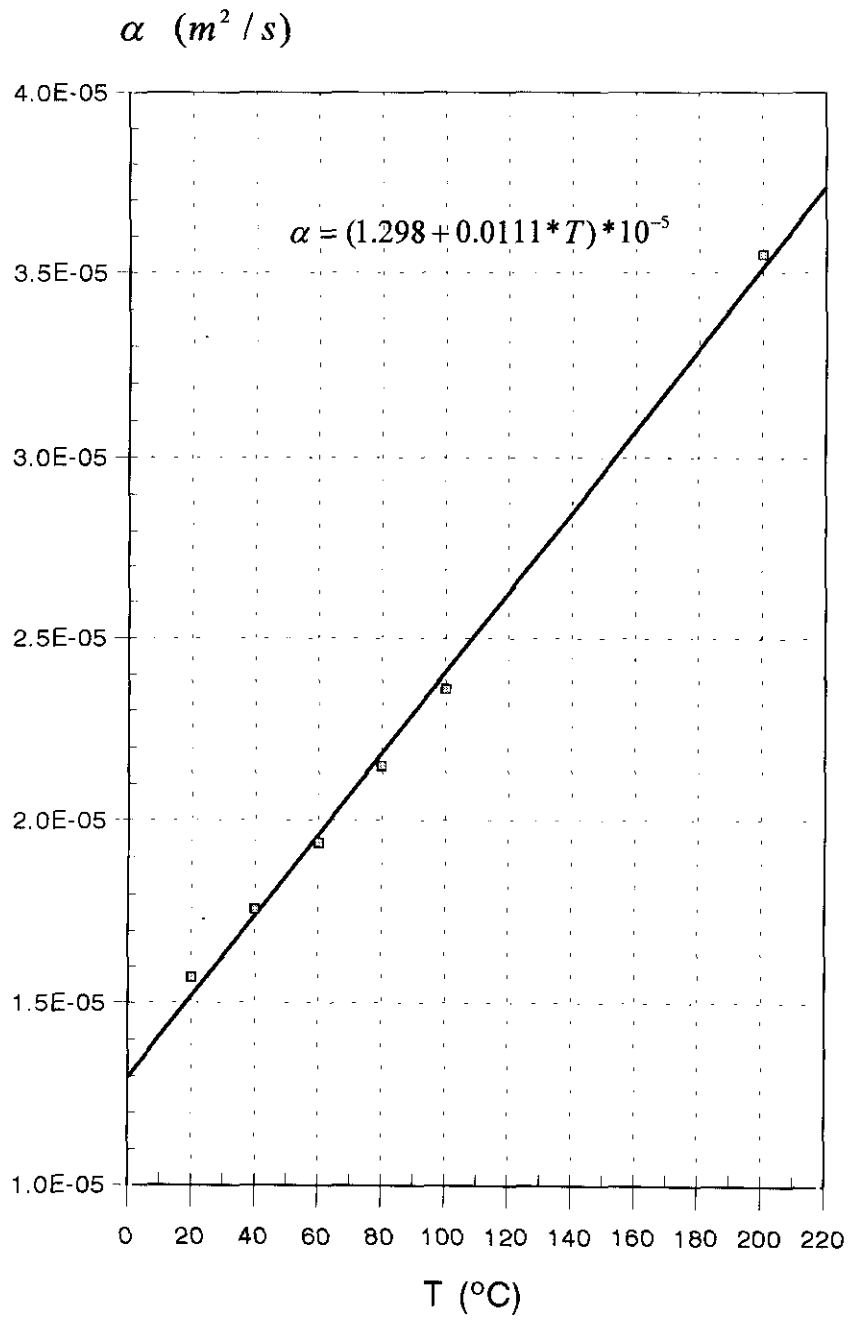

D.3. – Conductividad térmica

